

WRITE ON A FIRM SURFACE

USE BLACK INK BALL POINT PEN — PRESS FIRMLY
SIGN PERMIT APPLICATION

CONSTRUCTION LENDING AGENCY

I hereby declare under penalty of perjury that there is no construction lending agency for the purpose of Section 17000 of the California Building Code, issued by the State Board of Building and Fire Code Enforcement, in effect at the time of the issuance of this permit.

Contract Name _____
Contract Address _____

LICENSED CONTRACTORS DECLARATION

I hereby affirm under penalty of perjury that I am licensed under provisions of Chapter 170000 of the California Building Code, issued by the State Board of Building and Fire Code Enforcement, with Section 70000, of Division 3 of the Business and Professions Code and have this code in full force and effect.

License Class C-45 Lic. Number 576277
Date 3/1/01 Contractor Alan Ford
Signature _____

OWNER - BUILDER DECLARATION

I hereby affirm under penalty of perjury that I am exempt from the Contractors License Law and that I am not a contractor, as defined in the Contractors License Law, and that I am not acting as a contractor, as defined in the Contractors License Law, in connection with the construction of the above described project. I am not a contractor, as defined in the Contractors License Law, and I am not acting as a contractor, as defined in the Contractors License Law, in connection with the construction of the above described project.

SITE ADDRESS

1689 Arden Way Ste 2238 (Space # 2077) S-211

ASSESSOR PARCEL NO. 277-0960-07

PERMIT NO. 01

NAME OF APPLICANT	ADDRESS	ZIP CODE
LICENSED CONTRACTOR <u>Sign Development</u>	<u>1808 136th W. Ninth St</u>	<u>91776</u>
BUSINESS OWNER <u>Anchor Blue</u>	<u>1689 Arden Way</u> <u>Sacramento CA</u>	

SIGN INFORMATION

<input checked="" type="checkbox"/> ATTACHED	<input type="checkbox"/> INTERIOR / ELECT.	<input checked="" type="checkbox"/> SINGLE FACED
<input checked="" type="checkbox"/> ILLUMINATED	<input type="checkbox"/> NON-ILLUMINATED	<input type="checkbox"/> BILLBOARD / SUBDIVISION
<input checked="" type="checkbox"/> INDIVIDUAL LETTERS	<input type="checkbox"/> PAINTED ON BUILDING	<input type="checkbox"/> LOGO
<input checked="" type="checkbox"/> METAL	<input type="checkbox"/> POLE	<input type="checkbox"/> DOT/BLE FACED
<input type="checkbox"/> PLASTIC	<input type="checkbox"/> MONUMENT	<input type="checkbox"/> VINYL/GATOR FOAM
<input type="checkbox"/> WOODEN	<input type="checkbox"/> PROJECTING	<input type="checkbox"/> RE-FACE

SIGN COPY # ANCHOR BLUE

THIS IS AN INTERIOR WALL SIGN AT ARDEN FAIR

CITY OF SACRAMENTO PERMIT SERVICES
BUILDING INSPECTION DIVISION 264-7619

WORKER'S COMPENSATION DECLARATION

I hereby affirm under penalty of perjury that I am not a contractor, as defined in the Contractors License Law, and I am not acting as a contractor, as defined in the Contractors License Law, in connection with the construction of the above described project. I am not a contractor, as defined in the Contractors License Law, and I am not acting as a contractor, as defined in the Contractors License Law, in connection with the construction of the above described project.

Employer Name Anchor Blue
Policy Number 1155878

Date 3/1/01
Signature Alan Ford

OTHER: _____
TOTAL: _____

(A)

(B)

(C)

11'-0"

2'-6"

12"

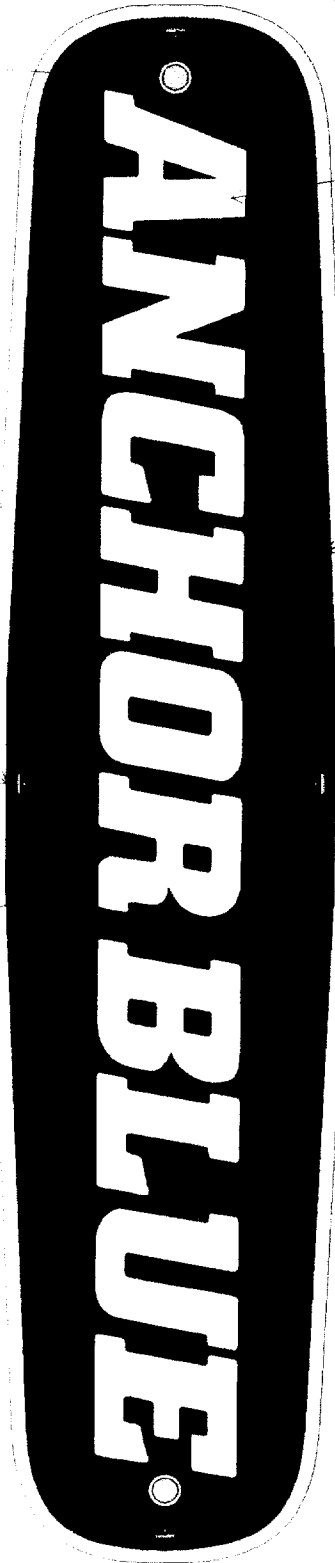

(E)

(F)

NOTES:

- (A) DUAL ILLUMINATED (HALO & FACE ILLUMINATED) LETTERS BRUSHED ALUMINUM RETURNS WITH SPECIAL WHITE TEXTURED FACES. INTERNAL DOUBLE TUBE WHITE NEON ILLUMINATION CLEAR LEXAN BACK.
- (B) SINGLE TUBE 15 MM EXPOSED NEON COBALT BLUE.
- (C) 1 1/4" BRUSHED ALUMINUM TUBE
- (D) 3" SQ. METAL TUBE SLEEVE PAINTED MATTHEWS 41-342 BRUSHED ALUMINUM FINISH (SLIDE OVER EXISTING 2 1/2" SQ METAL TUBES. TYPICAL OF 3)
- (E) CUT OUT DOT WITH 3/8" BRUSHED ALUMINUM BORDER TRIM. NON-ILLUMINATED
- (F) SILVER PLASTIC CLIP (4 TYPICAL)
- (G) PERFORATED METAL BACKGROUND (3/8" ROUND 9/16" STAGGERED) PANELS COLOR TO MATCH CORVEL PAINT #23-919

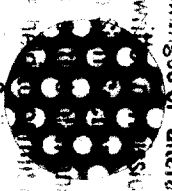
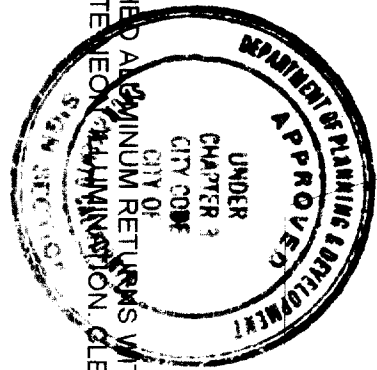

SCALE: 3/4" = 1'-0"

SIDE VIEW SCALE: 1 1/2" = 1'-0"

All electrical work on this sign shall be done in accordance with the National Electrical Code and the applicable provisions of the Chicago Electrical Code. The sign shall be installed in accordance with the Chicago Sign Ordinance and the Chicago Sign Code. The sign shall be installed in accordance with the Chicago Sign Ordinance and the Chicago Sign Code. The sign shall be installed in accordance with the Chicago Sign Ordinance and the Chicago Sign Code.

NOTE: TO LANDLORD/TENANT COORDINATOR
THIS ANCHOR BLUE SIGN SHOWN ON THIS PAGE
IS THE APPROVED REGISTERED CORPORATE
BRANDING STANDARDS FOR HUB DISTRIBUTING INC.

No. 2
 Date
 Signature
 Title

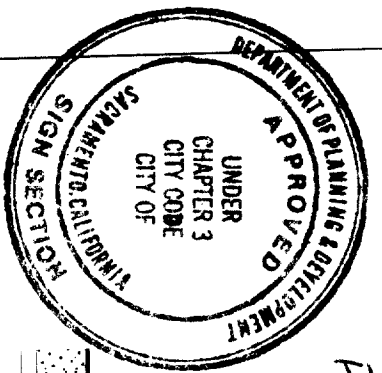

Permit # 0103376

This set of plans and specifications must be kept on the job at all times and it is unlawful to make any changes or alterations from the same without written permission from the City of Sacramento Sign Section.

The approval of this plan and specification

shall not be held in permit or approve the violation of any City Ordinance or State Law

All electrical work must be U.L. labeled or be of equivalent standards, N.E.C. Sec. 90-6/and comply with chapter 14, Div. 2 of Sacramento City Code.

EQUIPMENT MUST BE USED AS DESIGN INTENDED

ALL SIGN INSTALLATIONS ARE SUBJECT TO FIELD INSPECTIONS

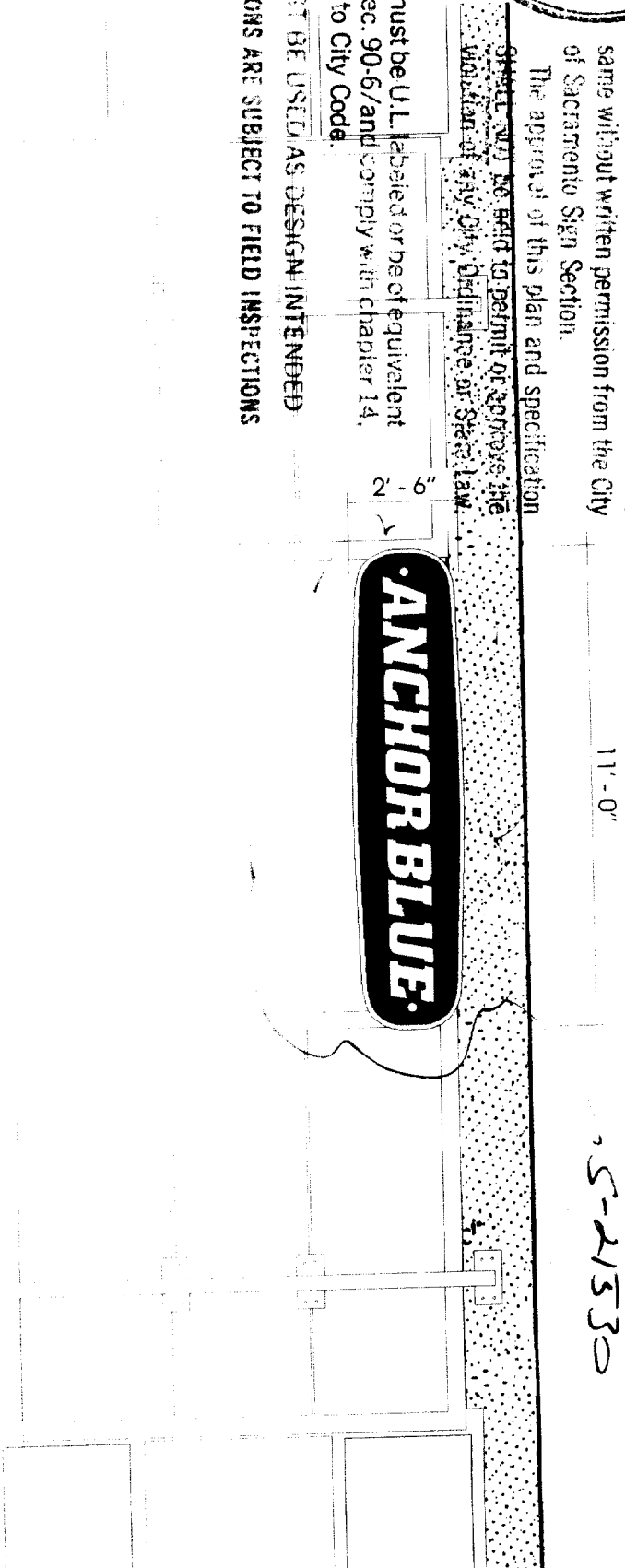

STOREFRONT PARTIAL ELEVATION

NOTE: TO LANDLORD/TENANT COORDINATOR
THIS ANCHOR BLUE SIGN SHOWN ON THIS PAGE
IS THE APPROVED REGISTERED CORPORATE
BRANDING STANDARDS FOR HUB DISTRIBUTING INC.

Provide Disconnector

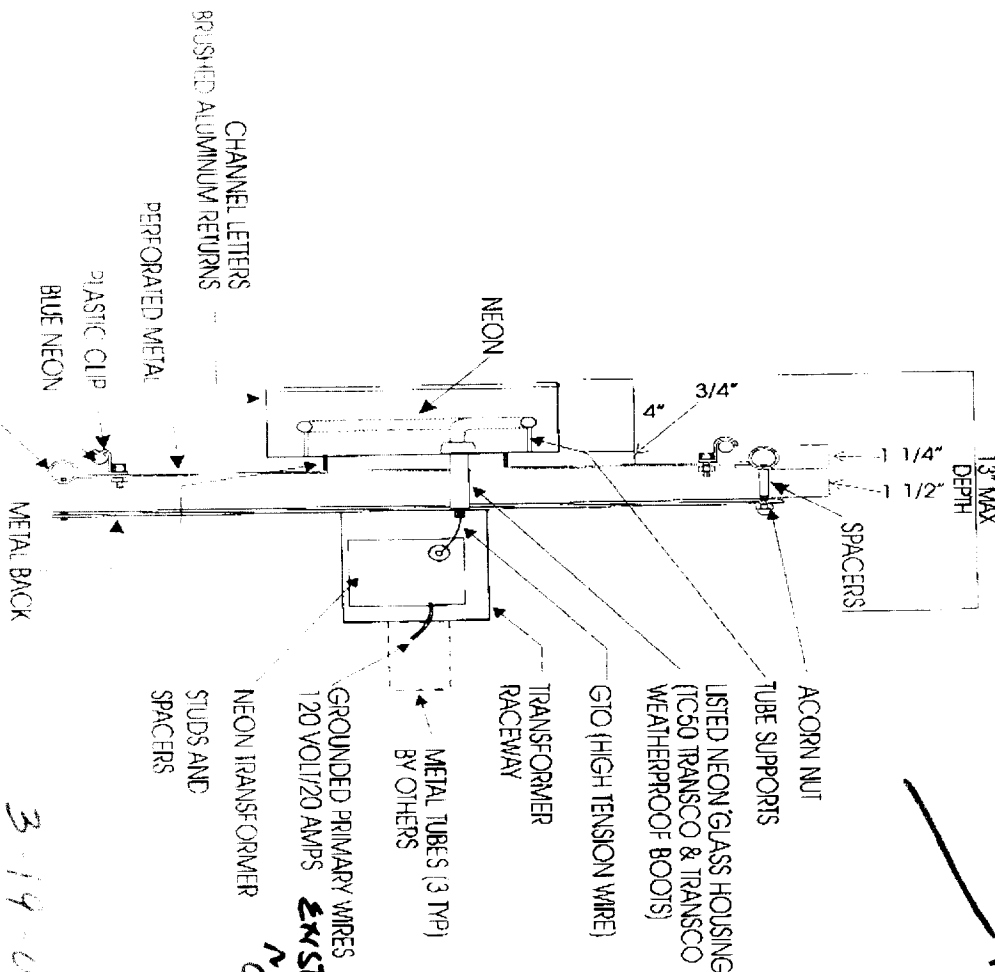

ANCHOR BLUE LETTER SECTION DETAIL

SCALE: 1 1/2" = 1'-0"

LISTED SIGN SECTION
CONSISTING OF INSULATING
BOOTS, INSULATING SLEEVES,
PLASTIC FACE, TUBE STANDS AND
CHANNEL LETTER RETURNS, SUITABLE FOR
OUTDOOR LOCATION;
CIRCUIT'S EXISTING

1 Sign

3-19-01

*existing circuit
ng's ok*

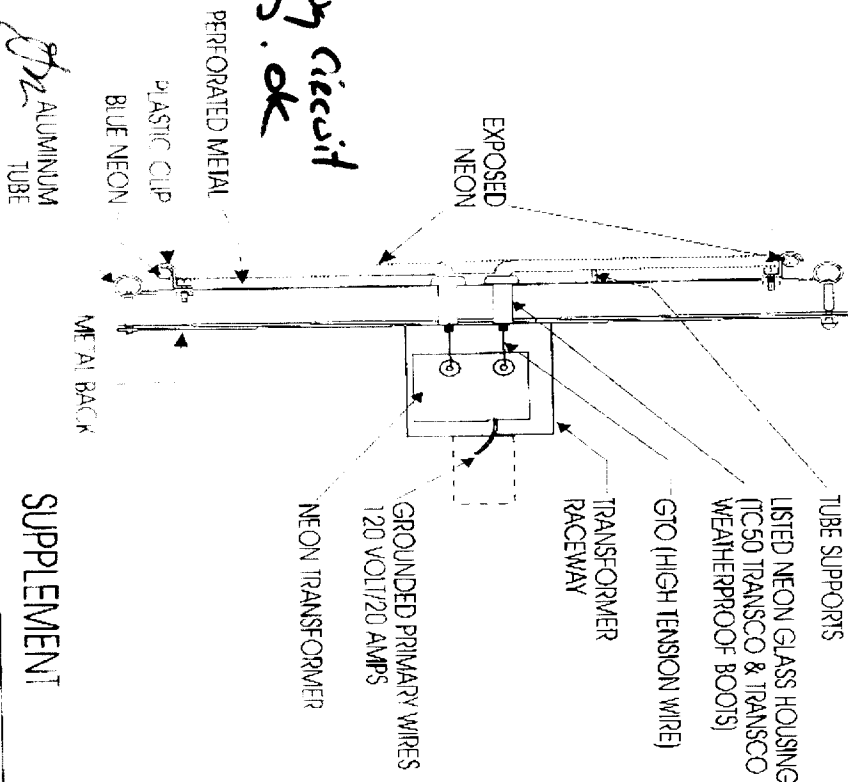

ANCHOR BLUE NEON END SECTION DETAIL

SCALE: 1 1/2" = 1'-0"

LISTED SIGN SECTION
CONSISTING OF INSULATING
BOOTS, INSULATING SLEEVES,
PLASTIC FACE, TUBE STANDS AND
CHANNEL LETTER RETURNS, SUITABLE FOR
OUTDOOR LOCATION;
CIRCUIT'S EXISTING

SUPPLEMENT



Sign Development Inc.

ANCHOR BLUE
ARDEN FAIR
SACRAMENTO, CA

Upland, CA 91786 (909) 920-5535

NO. 202064 Rev. 03/07/01

Date: 03/06/01

4' - 6" +/-

4' - 6" +/-

(D)

(E) CANOPY

(D)

Q

(D)

(A)

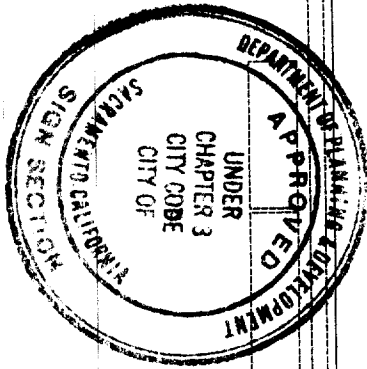

This set of plans and specifications must be kept on the job at all times and it is unlawful to make any changes or alterations from the same without written permission from the City of Sacramento Sign Section 91.1-0*
 The approval of this plan and specification SHALL NOT be held to permit or approve the violation of any City Ordinance or State Law.

All electrical work must be in accordance with the National Electrical Code, N.E.C. Section 90 and comply with Chapter 24 Div. 2 of Sacramento City Code.

EQUIPMENT MUST BE USED AS DESIGN INTENDED.
 ALL SIGN INSTALLATIONS ARE SUBJECT TO FIELD INSPECTION.

ANCHOR BLUE SIGN

RACEWAY

2' - 6"

NOTES:

- (A) ANCHOR BLUE SIGN ON RACEWAY
- (B) RACEWAY
- (C) 3/8" MACHINE BOLTS (GRADE 5 OR BETTER, 6 TYPICAL)
- (D) MOUNTING STRUCTURE (3 TYPICAL) - 2 1/2" X 2 1/2" X 1/4" SQ. TUBE WITH WELDED 1/4" PLATES PAINTED ALUMINUM FINISH, FIELD DRILL MOUNTING HOLES ON RACEWAY
- (E) CANOPY WITH MOUNTING HOLES - BY CONTRACTOR
- (F) 1/2" THRU BOLTS (6 TYPICAL)

SCALE: 3/4" = 1' - 0"

A

Update No. Date

(A)

(B)

11'-0"

(C)

NO PORTION OF SIGNAGE TO EXTEND MORE THAN 5" BEYOND LEASELINE, OR IN SOME CASES, FACE OF STOREFRONT POPOUT.

2'-6"

12'

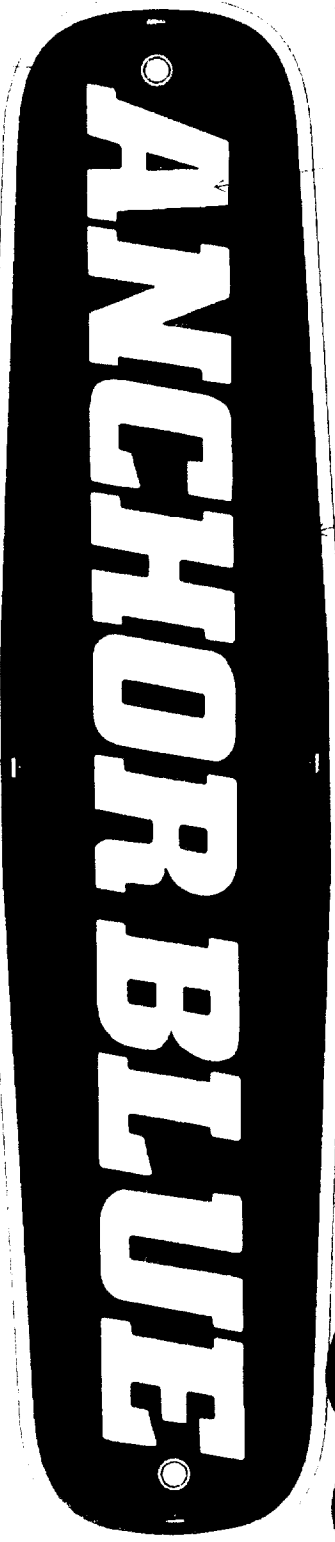

(E)

NOTES:

(F)

NO EXPOSED FASTENERS ON SIGNAGE PERMITTED

(G)

1" X PEG-OFF PERFOR

(A) DUAL ILLUMINATED (HALO & FACE ILLUMINATED) LETTERS, BRUSHED ALUMINUM RETURNS WITH SPECIAL WHITE TEXTURED FACES, INTERNAL DOUBLE TUBE WITH NEON ILLUMINATION, CLEAR LEXAN BACK

(B) SINGLE TUBE 15 MM EXPOSED NEON "COBALT BLUE"

(C) 1 1/4" BRUSHED ALUMINUM TUBE

(D) 2 1/2" SQ. METAL TUBES, TYPICAL OF 3 (PROVIDED BY CONTRACTOR)

(E) CUT OUT DOT, WITH 3/8" BRUSHED ALUMINUM BORDER TRIM, NON-ILLUMINATED

(F) SILVER PLASTIC CLIP (4 TYPICAL)

(G) PERFORATED METAL BACKGROUND (3/8" ROUND, 9/16" STAGGERED) PANELS, COLOR TO MATCH CORVEL PAINT #23-919

ALL PAINTING TO BE OF AUTOMOTIVE TYPE FINISH

SCALE: 3/4" = 1'-0"

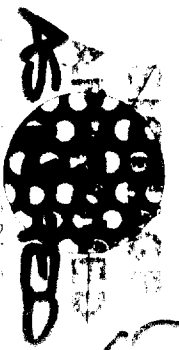

2014

SIDE SCALE: 1



NOTE: TO LANDLORD/TENANT COORDINATOR THIS ANCHOR BLUE SIGN SHOWN ON THIS PAGE IS THE APPROVED REGISTERED CORPORATE BRANDING STANDARDS FOR HUB DISTRIBUTING INC.

1/2 2/01 Sheruey
Macerich Co. Hydramo

UPPER LEVEL

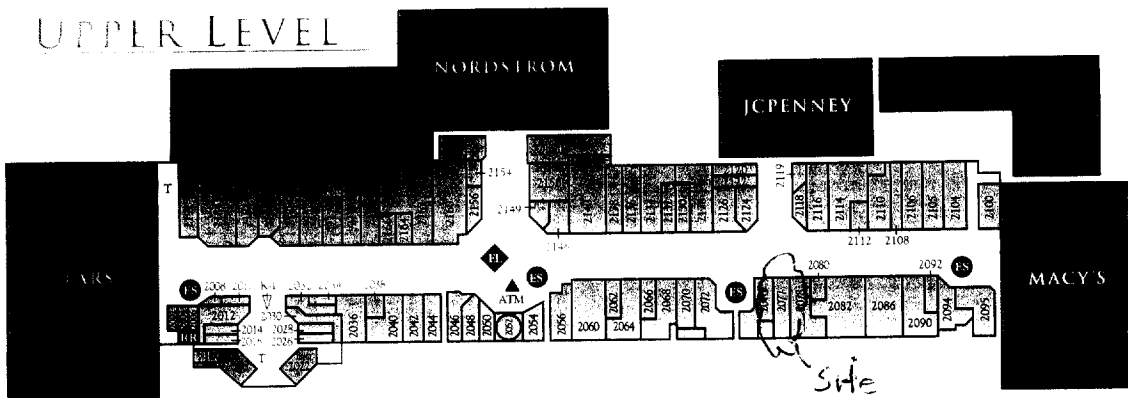

LOWER LEVEL

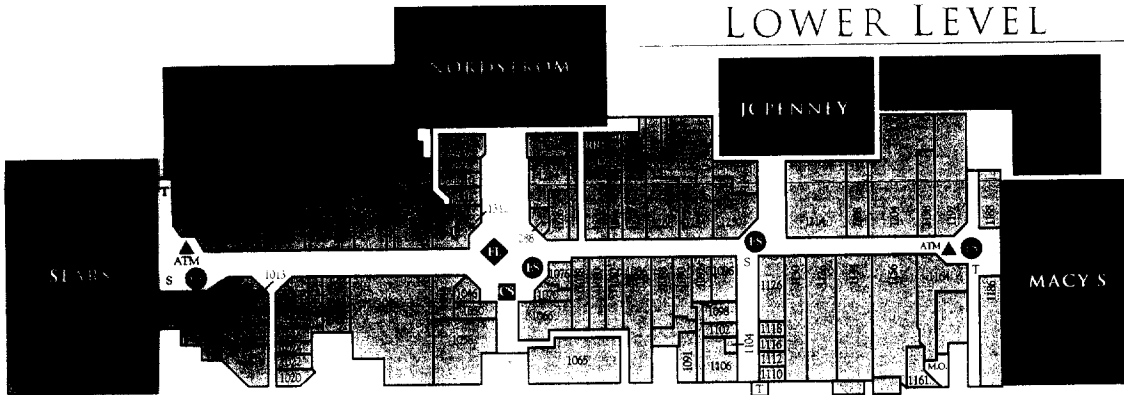

GENERAL STORES

JCPenney	94-0315
Macy's	94-2845
Nordstrom	94-2400
Sears	94-6100

CHILDREN'S FAMILY

15- American Eagle & Fitch	925-4219
16- American Eagle Outfitters	920-2485
19- Banana Republic	941-2767
20- Eddie Bauer	929-7071
31- Walmart	942-7242
207- Miller's Outpost	944-0977
205- Speedos Athletic Firms	941-2705
21- Sunrise Leather	940-5595
11- Wilson's Leather	941-7378

CHILDREN'S WOMEN'S

25- Ann Taylor	967-0290
26- bebe	920-2323
25- Anne	949-2228
32- Casual Women/Pette Sepulveda	942-5375
30- Dance Classics	925-7297
18- D'athome	925-8205
12- D'oberly	968-0468
10- Express	944-7342
20- Forever 21 of Hollywood	924-7124
19- Gap Brand	927-0081
20- Gap of New York	929-2804
7- Kate & The	922-8971
21- Kids Maternity	927-7120
17- Lane Road Maternity	940-0355
4- L'or	942-2137
2- L'or's Secret	945-3345
3- L'or's	49-2064

CHILDREN'S MEN'S

15- Hot Topic	923-1131
20- J2 Menswear	923-6359
21- Lacoste Sunwear	923-0311
22- L'or's	927-6689
1- L'or's	924-1547

CHILDREN'S SHOES & CHILDREN'S

20- Gap Day	948-3948
19- Children's Place	948-3948
20- Gap Kids	948-3948
20- Gymboree	929-0440
21- Kids Footlocker	922-5641
12- Limited Toe	927-8182
21- L'or's B'Gosh	924-0982
21- Stride Rite	948-1174

CHILDREN'S FURNISHINGS & ACCESSORIES

EAST FOOD

205- Auntie Anne's Pretzels	925-1630
217- Burger King	929-3792
207- Cafe Empo	929-4140
K- Caramel Corner	925-4880
203- Chicago Hot Dog	922-8507
202- The Inn	920-0959
202- S'mores	927-1964
1124- Hot Dog on a Stick	1-800-321-8400
201- La Salsa	565-0144
201- Dish Kitchen	920-5578
203- Paradise Bakers	568-5890
1118- Pretz-a-Time	924-0332
204- Sharps	920-9709
201- Steak House	924-8552

CHILDREN'S SERVICES

207- Godrick Chocolatier	649-1906
134- Hicson Farms	927-5336
210- Mrs. Figgy's Cookies	927-5483
111- Orange Julius Just Juice	646-6484
137- See Us Hands	925-7353
210- Stranek's	568-7420
210- Sweet Dreams	929-5133

CHILDREN'S SERVICES

135- Children's Cafe	925-2233
135- Fresh Bakery	649-3539
111- L'or's Bakery	944-9567

CHILDREN'S SERVICES & ACCESSORIES

18- Avenue of Music	565-1544
210- Electronic Boutique	946-9404
210- Let's Talk Cellular	641-0299
210- Raw Shack	922-4703
208- Software City	649-2607
217- Sun Coast Video	921-6627
210- Warehouse, The	923-9151

HOME FURNISHINGS & ACCESSORIES

200- Bonbay Company, The	927-9296
127- Eddie Bauer Home Collection	929-7032
128- Illuminations	922-9663
210- Leclair's Housewares	924-9879
110- Mel's Station	649-2725
108- More Fabrics	923-3503
209- Pure Plus	641-2655
110- Select Comfort	929-5296

JEWELRY

137- Afterthoughts	920-1429
210- Bailey Banks & Biddle	561-0525
210- Charles Boutique	922-9951
110- Croscom Jewellers	925-5177

SERVICES

1091- Eye Design	929-5909
1098- Glamour Shots	923-3881
1281- Heakin Research	920-1361
1344- Lenscrafters	922-5666
2120- Mastercuts	921-2211
2100- Pearle Vision	648-0209
1000- Picture People, The	922-4581
1022- ProffoNail	564-9343
1024- Regis Hair Salon	920-2220

SHOES

2150- Aerosoles	922-5874
1080- Aldo Shoes	641-2247
2136- Bostonian Shoes	921-5141
2044- Cathy Jean	924-1017
1350- Footaction	564-4160
1280- Footlocker	925-1696
2118- Jarman Shoes	923-1454
2036- Journeys	568-6440
1334- Kids Footlocker	922-5641
2040- Lady Footlocker	921-9909
2072- Leed's Shoes	929-4250
1198- Naturalizer	564-0543
2112- Stride Rite	648-1174
2110- Track 'n Trail	565-1170
1034- Walking Company, The	649-9255

SPECIALTY GIFTS

2132- Ashley Avery Collectables	927-6540
1090- Brookstone	922-2980
2174- Things Remembered	646-1742
2094- Truly Unique Collectables	641-0793

SPORTS

1006- Copeland Sporting Goods	648-0551
1246- Sports Fever	920-3387

SPECIALTY

2006- Briar Patch Smoke Shop	929-8965
1250- Discovery Channel Store, The	641-5446
2060- Disney Store, The	923-9165
1144- FAO Schwarz	564-5500
2050- Game Keeper	929-2655
1028- Gingsiss Formalwear	925-4766
2095- Kay Bee Toys	925-4501
2046- Natural Wonders	567-0551
1088- Right Start, The	563-0540
1340- Ritz Camera One Hour Photo	925-6285
1102- Sanrio Surprises	923-0065
1188- Spencer Gifts	922-9277
1030- Sunglass Hut	922-3775
2034- Sunglass Hut	923-6071
1214- Warner Bros.	564-0220