

CITY OF SACRAMENTO

Permit No: 0401476

1231 I Street, Sacramento, CA 95814

Insp Area: 2

Thos Bros: 336G1

Site Address: 6 PAYNE RIVER CR SAC

Sub-Type: RES

Parcel No: 031-0450-028

Housing (Y/N): N

CONTRACTOR

A A A STEINER'S SOLAR SERVICE
7232 QUIL RD
FAIR OAKS CA 95628

OWNER

NG MURRAY DALE
6 PAYNE RIVER CR
SACRAMENTO CA 95831

ARCHITECT

Nature of Work: SOLAR SYSTEMS FOR POOL.

CONSTRUCTION LENDING AGENCY: I hereby affirm under penalty of perjury that there is a construction lending agency for the performance of the work for which this permit is issued (Sec. 3097, Civ. C).

Lender's Name Lender's Address

LICENSED CONTRACTORS DECLARATION: I hereby affirm under penalty of perjury that I am licensed under provisions of Chapter 9 (commencing with section 7000) of Division 3 of the Business and Professions Code and my license is in full force and effect.

License Class C46 License Number 476360 Date 1/30/04 Contractor Signature

OWNER-BUILDER DECLARATION: I hereby affirm under penalty of perjury that I am exempt from the Contractors License Law for the following reason (Sec. 7031.5, Business and Professions Code; any city or county which requires a permit to construct, alter, improve, demolish, or repair any structure, prior to its issuance, also requires the applicant for such permit to file a signed statement that he or she is licensed pursuant to the provisions of the Contractors License Law (Chapter 9 (commencing with Section 7000) of Division 8 of the Business and Professions Code) or that he or she is exempt therefrom and the basis for the alleged exemption. Any violation of Section 7031.5 by any applicant for a permit subjects the applicant to a civil penalty of not more than five hundred dollars (\$500.00);

I, as a owner of the property, or my employees with wages as their sole compensation, will do the work, and the structure is not intended or offered for sale (Sec. 7044, Business and Professional Code: The Contractors License Law does not apply to an owner of property who builds or improves thereon, and who does such work himself or herself or through his/her own employees, provided that such improvements are not intended or offered for sale. If, however, the building or improvement is sold within one year of completion, the owner-builder will have the burden of proving that he/she did not build or improve for the purpose of sale.)

I, as owner of the property, am exclusively contracting with licensed contractors to construct the project (Sec. 7044, Business and Professions Code: The Contractors License Law does not apply to an owner of property who builds or improves thereon, and who contracts for such projects with a contractor(s) licensed pursuant to the Contractors License Law).

I am exempt under Sec. B & PC for this reason:

Date Owner Signature

IN ISSUING THIS BUILDING PERMIT, the applicant represents, and the city relies on the representation of the applicant, that the applicant verified all measurements and locations shown on the application or accompanying drawings and that the improvement to be constructed does not violate any law or private agreement relating to permissible or prohibited locations for such improvements. This building permit does not authorize any illegal location of any improvement or the violation of any private agreement relating to location of improvements.

I certify that I have read this application and state that all information is correct. I agree to comply with all city and county ordinances and state laws relating to building construction and herby authorize representative(s) of this city to enter upon the abovementioned property for inspection purposes.

Date 1/30/09 Applicant/Agent Signature

WORKER'S COMPENSATION DECLARATION: I hereby affirm under penalty of perjury one of the following declarations:

I have and will maintain a certificate of consent to self-insure for workers' compensation as provided for by Section 3700 of the Labor Code, for the performance of work for which the permit is issued.

I have and will maintain workers' compensation insurance, as required by Section 3700 of the Labor Code, for the performance of the work for which this permit is issued. My workers' compensation insurance carrier and policy number are:

Carrier NO EMPLOYEES Policy Number Exp Date

(This section need not be completed if the permit is for \$100 or less) I certify that in the performance of the work for which this permit is issued, I shall not employ any person in any manner so as to become subject to the workers' compensation laws of California and agree that if I should become subject to the workers' compensation provisions of Section 3700 of the Labor Code, I shall forthwith comply with those provisions.

Date 1/30/09 Applicant Signature

WARNING: FAILURE TO SECURE WORKER'S COMPENSATION COVERAGE IS UNLAWFUL AND SHALL SUBJECT AN EMPLOYER TO CRIMINAL PENALTIES AND CIVIL FINES UP TO ONE HUNDRED THOUSAND DOLLARS (\$100,000) IN ADDITION TO THE COST OF COMPENSATION, DAMAGES AS PROVIDED FOR IN SECTION 3706 OF THE LABOR CODE, INTEREST AND ATTORNEY'S FEE.

THIS PERMIT SHALL EXPIRE BY LIMITATION IF WORK IS NOT COMMENCED WITHIN 180 DAYS.

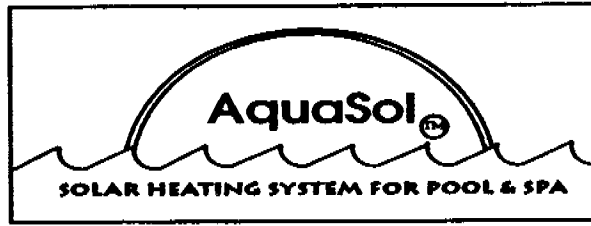

SAVE INSTALLATION TIME AND AVOID CALL-BACKS
 READ THIS MANUAL BEFORE MOUNTING COLLECTORS

SWIMMING POOL
 SOLAR HEATING SYSTEMS
 INSTALLATION MANUAL FOR
 AQUASOL SOLAR COLLECTORS

FOR MODEL NUMBERS:
 AQ32 AQ40 AQ48

ISSUED
 JAN 30 2004
 Sacramento Building Division

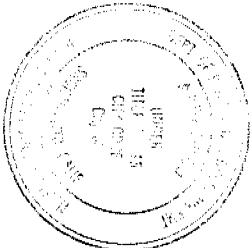

This set of plans and specifications must be kept on the job at all times and it is unlawful to make any changes or alterations to the same without written permits from the Building Inspection Division.
 The approval of this plan on specification SHALL NOT be held to permit the violation of any City Ordinance or State Law.

MANUAL CONTENTS

This manual provides a detailed step-by-step procedure for the installation of an AquaSol solar pool heating system. If the directions are followed correctly and only recommended AquaSol hardware and components are used, the installed system should provide years of trouble free service, savings, and enjoyment.

CAUTION: SOLAR COLLECTORS ARE OFTEN INSTALLED ON THE ROOFS OF BUILDINGS. UNLESS YOU ARE VERY FAMILIAR WITH WORKING ON ROOFS AND HAVE THE PROPER LADDERS AND SAFETY EQUIPMENT FOR SUCH WORK, YOU SHOULD HIRE SOMEONE WITH THE NECESSARY EXPERIENCE TO DO THE INSTALLATION. FAILURE TO OBSERVE SAFE PRACTICES ON A ROOF OR OTHER ELEVATED STRUCTURE MAY RESULT IN FALLING, LEADING TO SERIOUS INJURY.

CITY COPY

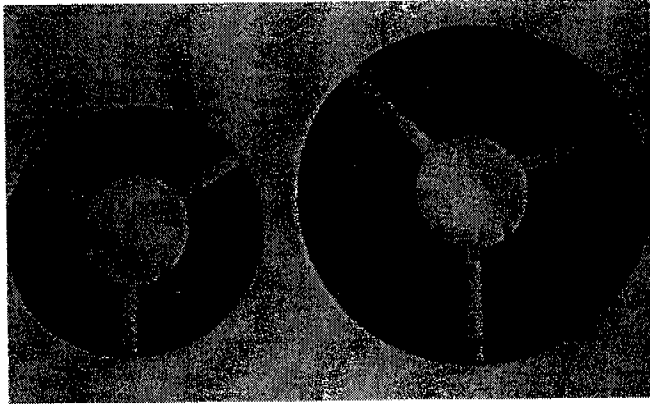

(2) Hold-Down Strap is required to secure collectors to the mounting surface. Use strap 10035-1 (54') for rows of up to 6 collectors or strap 10035-2 (107') for rows of up to 12 collectors.

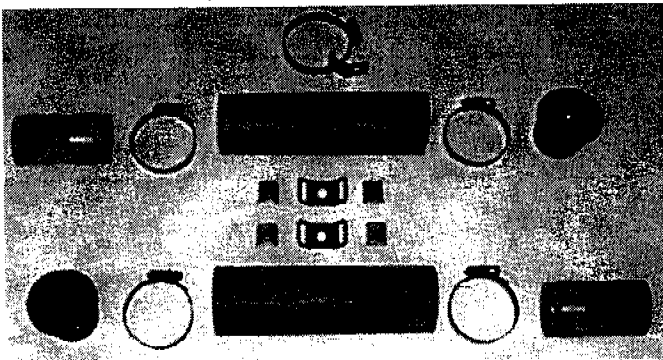

(3) The System Kit (Part# 12043-1 for 1.5" & Part #12043-2 for 2" kit) is needed to complete water connections from the collectors to the system feed and return line. Use one kit per system. When more than one row of collectors is to be installed, use additional kit per each collector row after the first.

| Part No. | Qty 1 1/2" | Qty 2" | Description |
|----------|------------|--------|--|
| 10003-1 | 1 | | Vacuum Relief Valve |
| 10003-2 | | 1 | Vacuum Relief Valve |
| 10008-1 | 1 | | Outlet header hold-down bracket assembly |
| 10008-2 | | 1 | Outlet header hold-down bracket assembly |
| 10011 | 4 | 4 | Hold-down strap clamp assembly |
| 30061-1 | 1 | | End Cap |
| 30061-2 | | 1 | End Cap |
| 30089-1 | 2 | | Pipe adapter |
| 30089-2 | | 2 | Pipe adapter |
| 50006 | 2 | 2 | Hold-down strap bracket |
| 60001-2 | 2 | | System connector hose (7' long) |
| 60002-2 | | 2 | System connector hose (7' long) |
| 60546-1 | 4 | | Hose clamp, stainless steel |
| 60546-2 | | 4 | Hose clamp, stainless steel |

(4) Double Hole Outlet Header Bracket (Part #50069) may be used on steep roof applications or in high wind areas where extra hold-down strength is required.

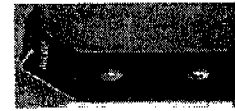

(5) Aluminum Mounting Bracket & Header Clamp Assembly



The Aluminum Header Bracket (Part #30171-1 for 1 1/2"; #30177-1 for 2") is used as optional outlet header mounting hardware. It replaces or can be used in conjunction with the Outlet Header Hold-Down Bracket assembly (10008-1/-2). The bracket is designed for installations that require more flexibility for the outlet header mounting hardware location, such as barrel tile roofs or installations that require mounting hardware to be anchored into rafters or beams.

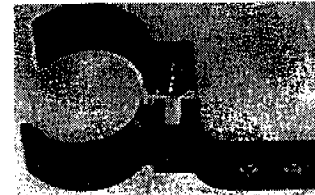

The Aluminum Header Clamp Assembly (Part #10117-1 for 1 1/2"; #10117-2 for 2") is used the same as the Aluminum Header Bracket (30171-1) and allows for collector replacement without disturbing the roof penetrations.

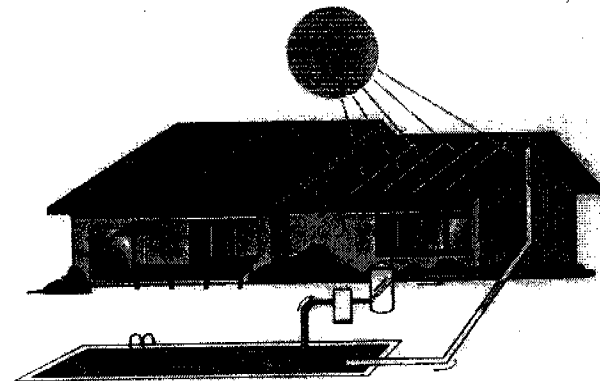

1) Determine the position of the last outlet header hold-down bracket for the row of collectors. Mark this point on the roof. The collector outlet headers will be located approximately 1" (25mm) below this mark. Refer to Figure 3.

Figure 3

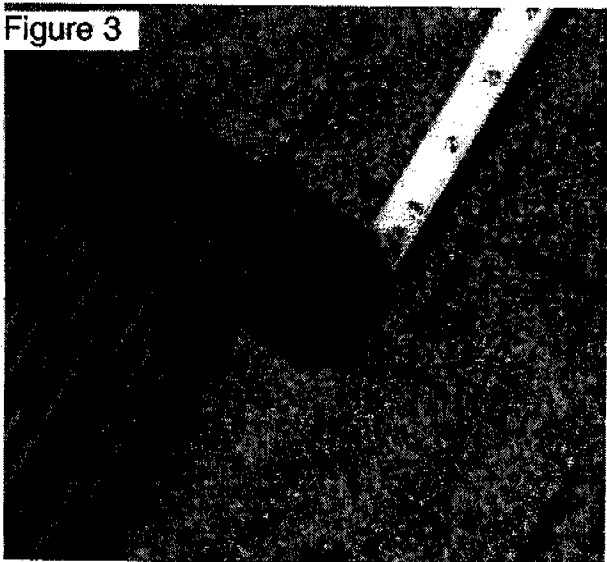

2) Using this point, snap a chalk line to the opposite end of the row. This line would slope down the roof toward inlet approximately 1" (25mm) for each six (6) collectors in the row. Drill a hole for the first outlet header bracket on the first roof mark. Measure 51" (1.3m) further along the chalk line, mark, and drill a second hole. Use a 3/16" (5mm) drill for 5/16" (8mm) diameter screws. Then continue drilling pilot holes all along the chalkline for the total number of collectors which you are using for the job.

Figure 4



3) Inject a generous amount of high quality sealant into each hole and onto the surrounding roof surface. Bolt all the outlet header hold down brackets to the roof as shown in Figure 4.

Figure 5

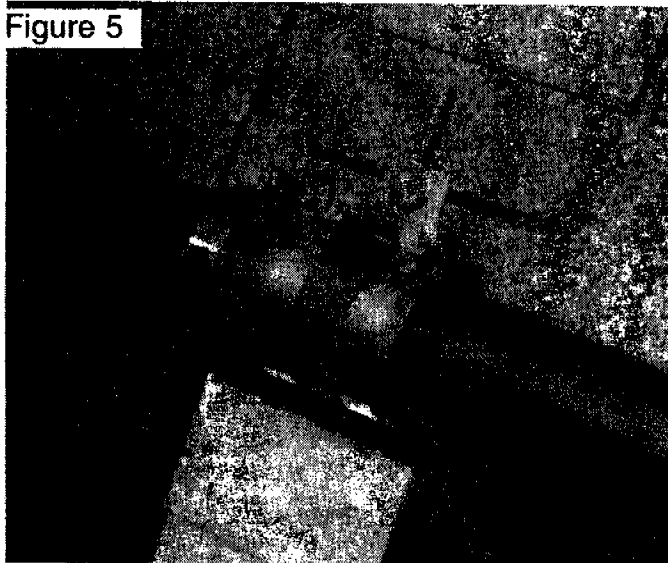

4) Locate the hold-down strap bracket holes using the information in Fig. 1, Table A. Measuring from the top outlet header bracket chalk line, snap another chalk line parallel to this line using the "A" dimension. The "B" dimension is the same for all collector sizes, which is 16" (40cm) up from the outside of the bottom header and can be measured after the collectors are installed. Wait to install the hold-down strap brackets until after the collectors are installed so as not to damage the collectors when you are bringing them to the roof for installation.

5) Bring the first collector to the roof and slip the proper hoses over both ends of the inlet and outlet headers on the last return collector. Make sure that the side of the collector with the serial number label on its facing down. The long hoses go on the outlet of the last collector and the inlet of the first collector. Push UP TO the hose locating shoulder, but NOT OVER it. Locate a hose clamp 3/8" (10mm) from the end of the hose in order to center it on the header groove. This clamp must face up so as to be accessible for tightening and will not rub against the mounting surface. Make sure you securely tighten each clamp with a nutdriver. If a nutdriver is not available, a 'hex' wrench or screwdriver will suffice. **THE HOSE CLAMPS MUST BE LOCATED OVER THE GROOVES IN THE HEADER.**

6) Position the collector on the roof so that the center of the outlet connection hoses are directly beneath the secured outlet header brackets and slip the bracket hold-down clamps over the connection hoses. Lightly tighten the clamp around the header hose. Refer to Figure 5. Continue to install all the collectors in the array, coupling them side to side.

With a roof vent pipe of 3" (8cm) in diameter, the collectors can be positioned on either side of the vent. Two system collector hoses (Part #60001-2) can be employed to couple the collectors together for vent pipes or other obstacles up to 7" (17cm) in diameter. Mark your 51" (1.3cm) centers wherever the outlet header brackets 'fall' on the upper chalk line. With obstructions of over 7" (17cm), such as attic fans and skylights, lay out the collectors on either side of the obstruction using a Row Spacer Kit (Part #12017-1 for 1 1/2"; #12017-2 for 2").

System Piping

Refer to Figures 10 & 11, throughout this section. The most common piping configurations use a pressure filter. The pump draws the water from the skimmer and/or a main drain, forcing it through the filter and sending it back to the pool through the return lines.

If a fuel-fired heater is installed, it is located between the filter and the return line to the pool. The pipes to and from the solar collectors are connected to the return line to the pool before the water enters the fuel-fired heater, if one is used.

Whenever there is more than 40 gpm (151.6) required flow rate to the collectors or more than 100' (12m) of piping used in a system, install 2" (63mm) piping to and from the collectors.

Piping to and from the collectors should be the same type of plastic piping and fittings approved for use with swimming pool filters and pumps. It is recommended to always use Schedule 40 PVC pipe and fittings. Although PVC pipe is generally white, black is also available but may be difficult to find locally. If for aesthetics black pipe is desired it can always be painted black. Use a PVC cutter or a PVC wideblade saw (not a hacksaw) for cutting pipe. It is important to use both a quality cleaner/primer and solvent in gluing a PVC joint. For more detailed information on PVC gluing refer to Engineering Bulletin No. 8701. Finally, use a cloth while either gluing or painting to keep the job a clean one. Piping should also be supported at intervals of 5' (1.5m) for horizontal pipe and 8' (2.5m) for vertical pipe. Use either galvanized or plastic pipe clamps. Aquasol outlet header bracket assemblies (Part #10008-1/-2), which are made of stainless steel, are also excellent pipe hangers.

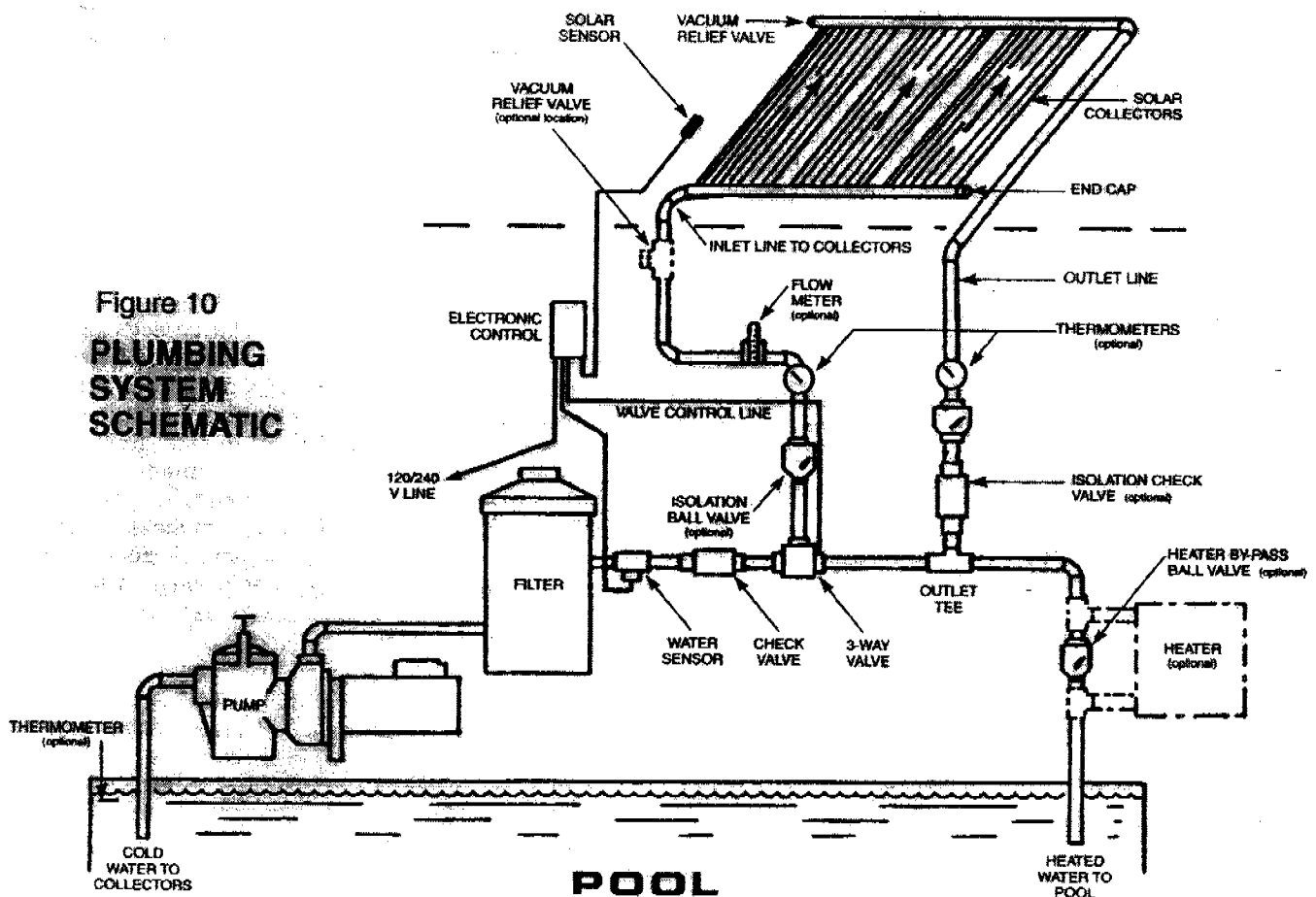

Figure 10
PLUMBING
SYSTEM
SCHEMATIC

Special System Layouts

Use a divided system when installing more than the recommended maximum number of collectors per row, when avoiding roof obstructions, or where limited space dictates. This provides uniform distribution of water through all the collectors. If water distribution through the collectors is non-uniform, the heating capacity of the system will be reduced.

WHEN INSTALLING A DIVIDED SYSTEM, THE OUTLET HEADERS FROM EACH OF THE LOWER (OR CLOSEST) ROWS OF COLLECTORS MUST BE CONNECTED TO THE HIGHEST (OR FURTHEST) POINT IN THE SYSTEM. Refer to Figure 11.

A divided system requires an additional system kit (Part #12043-1/-2) for each row of collectors. A more complex divided system is shown in Figure 12. This also illustrates the application of the Row Spacer Kit to clear a roof obstruction.

Booster Pump System

In some cases, the pool filter pump may not be able to circulate water at a high enough flow rate to allow for proper collector operation. If so, it may be necessary to replace the filter pump with a larger one or add a booster pump. If the pump size is increased, it may also be necessary to upgrade the filter with one with greater flow ratings.

Supplemental Gas, Oil-Fired, or Electric Heaters

It is desirable to pipe the stand-by heater in a bypass loop. Refer to Figure 10. Fuel-fired heaters often create a large pressure drop. By placing a heater in a by-pass loop, pump size, and electrical energy requirements may be reduced.

SYSTEM START-UP AND TEST

System Start-up and Checkout for Automatic Systems

To check out the system for proper operation turn on the filter system. Set the temperature control to its highest level. Switch the control to the "flow through collector" mode. The "flow through collector" light should come on. The 3 way valve will then be sending water thru the collectors, and air will be purged out of the collectors into the pool return line for several minutes, and should then clear. The collectors should feel uniformly cool to the touch. Switch the control to the "bypass collector" mode. The corresponding light will go on and the 3 way valve will be sending water directly back to the pool, bypassing the solar collectors. After about 5-10 minutes, feel the solar collectors again. They should have begun to warm up. Now switch back to the automatic mode. If the sun is still shining on the solar collectors, the "flow thru collector" light should go on again. Adjust the temperature control lower.

When you reach the actual temperature of the pool water, the light will turn off. The flow bypass collector light will go on again. Move the temperature control to maximum and leave there. The "flow through collector" light will go back on. For more detailed information on the system startup, trouble shooting and valve/control installation, follow the manufacturers' instructions included with the automatic control system.

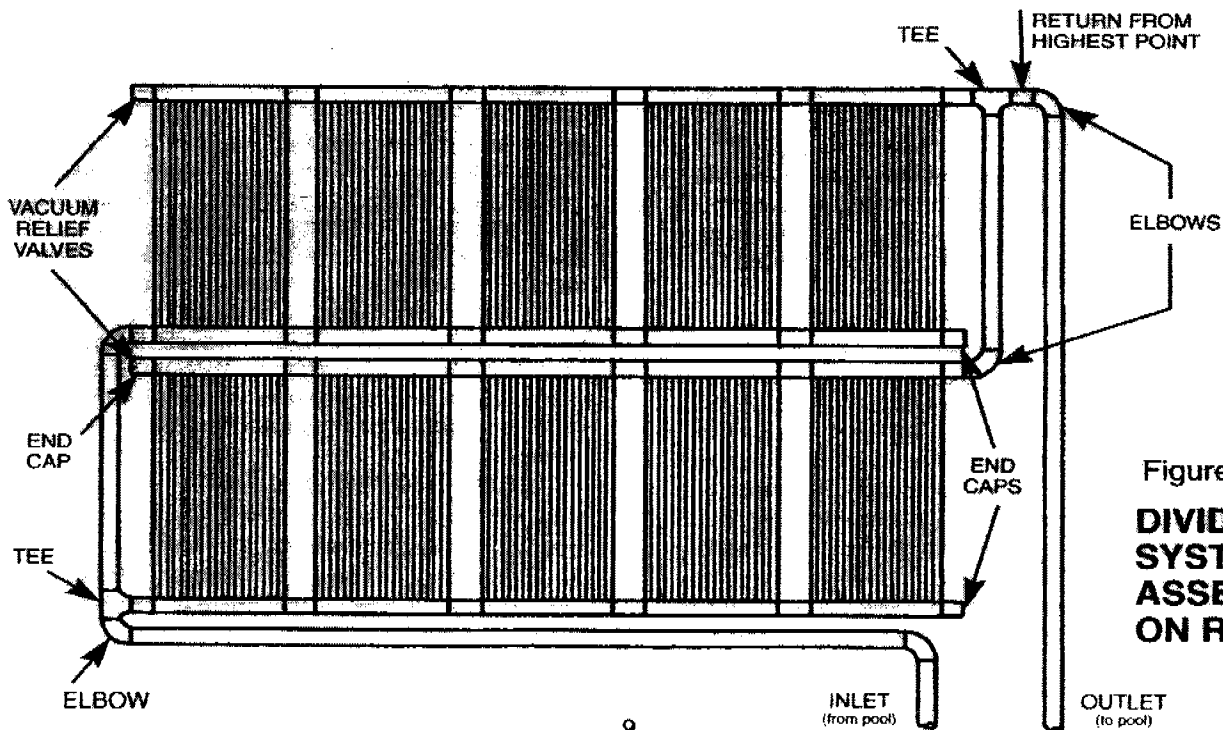

Figure 11
**DIVIDED
SYSTEM
ASSEMBLY
ON ROOF**

remove the vacuum relief valve(s) and replace it with an end cap. Relocate a vacuum relief valve to a position in the inlet piping which is at a height of approximately three-fourths of the elevation of the collectors above the pool. Refer to Figure 1. (A quicker alternate method is to first try to reverse the end cap and the vacuum relief valve on the collector array to see if this stops the bubbles in the return lines. Sometimes the end cap is about 3/4 of the elevation of the collectors and this is a lot quicker than cutting in a tee in the supply pipe.)

MAINTENANCE

Winterizing Procedures

The solar collectors should drain automatically each time the pump cycles off. There are no special requirements for winterizing the solar collectors. The pool piping should be winterized as per your normal practice. In Southern parts of the country pool owners operate their pools throughout the winter although light freezing conditions may occur. The accepted procedure for avoiding freezing of the pool piping and filtration system has been to continuously circulate the water. When solar heaters are used on a pool under these conditions, anti-freeze precautions should be taken. Aquasol solar collectors are not normally affected by light freezing. However, in order to protect appurtenant components such as end caps and pipe fittings and the collectors against unusual or severe freezing conditions, one of the following two procedures should be followed when freezing weather is imminent.

1. Turn circulating system off and allow solar collectors and piping to drain. Isolate collectors with gate or ball valve in collector feed line and a check valve in the collector feed line and a check valve in the collector return line. Switch the solar control to the bypass position. The pool filtering system may then be turned back on. When freezing conditions have passed, open isolation valves and switch the solar control collector to "AUTO".

2. Switch the solar control collector of the "COLL" position so that the water circulates through the collector. When freezing conditions have passed, switch the solar control collector to "AUTO". **THIS METHOD IS NOT RECOMMENDED WHERE TEMPERATURE LEVELS MAY DROP SEVERELY.**

Annual Service Collector Clamps:

In particularly hot climates, such as Arizona and Southern Florida, the clamps which are used to connect the solar collectors may become loose. If you notice leaks around the hose couplings, use a nutdriver to tighten clamps. Do not tighten to the extent that the pipe collapses or the clamp gears strip. In areas where unusually high stagnation temperatures are prevalent or where abnormally high system pressures occur, use header insert (Part #50055-1/-2).

COLLECTOR REPAIR

- (1) This method allows for an easy and permanent on site repair of a collector by isolating the leaking riser tube. Referring to the figure below, locate the tube to be isolated. (End tube has been shown for clarity.) Using a sharp utility knife, very carefully cut away approximately 1" of the tube at both headers. Drive a #10-#12 sheet metal screw, preferably stainless, into the hole in the header. The screw must be between 1/2" and 3/4" long. **DO NOT OVERTIGHTEN!** If the screw strips out, or if the repair leaks, use a larger screw.

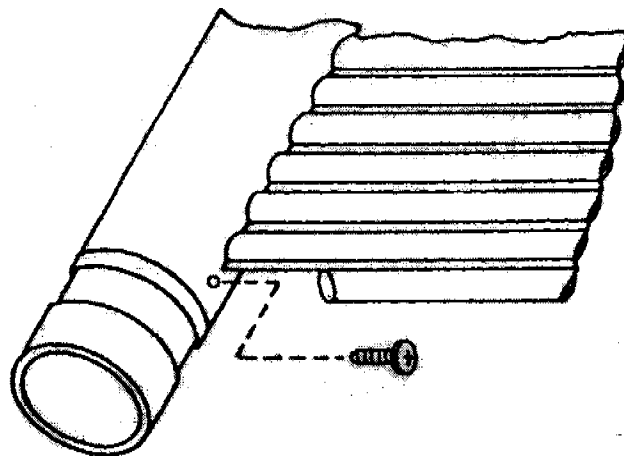

- (2) Locate the leak and with a sharp utility knife cut through the tube at the leak. Cut the web length wise on each side of the tube about an inch above and below the leak area, enough so that either section of the tube may be pushed downward.

Insert repair plugs, Part No. 30143 in the tube openings, one above and one below the leak area. Use a #0 Phillips head screwdriver inserted into the hollow conical shaped end of the plug to push the plug into place. Bring the damaged section of the tube back to its former position, restoring the original appearance of the collector. This repair method will not void the collector warranty.