

CITY OF SACRAMENTO

Permit No: 0200247

1231 I Street, Sacramento, CA 95814

Insp Area: 4
Thos Bros: 277 B4

Site Address: 3271 AZEVEDO DR SAC
Parcel No: 225-0230-048

Sub-Type: REP
Housing (Y/N): N

CONTRACTOR
PAUL SEAGRAVES INC
8665 BLUE JAY WY
CIT HTS CA 95610

OWNER
HARSCH INVESTMENT
1121 S.W.SALMON ST
PORTLAND OREGON 97205

ARCHITECT

Nature of Work: DRY ROT REPAIR TO EXTERIOR STAIRWAYS

CONSTRUCTION LENDING AGENCY: I hereby affirm under penalty of perjury that there is a construction lending agency for the performance of the work for which this permit is issued (Sec. 3097, Civ. C).

Lender's Name _____ Lender's Address _____

LICENSED CONTRACTORS DECLARATION: I hereby affirm under penalty of perjury that I am licensed under provisions of Chapter 9 (commencing with section 7000) of Division 3 of the Business and Professions Code and my license is in full force and effect.

License Class 31 License Number 288304 Date 3.5.02 Contractor Signature [Signature]

OWNER-BUILDER DECLARATION: I hereby affirm under penalty of perjury that I am exempt from the contractors License Law for the following reason (Sec. 7031.5, Business and Professions Code; any city or county which requires a permit to construct, alter, improve, demolish, or repair any structure, prior to its issuance, also requires the applicant for such permit to file a signed statement that he or she is licensed pursuant to the provisions of the Contractors License Law (Chapter 9 (commencing with Section 7000) of Division 8 of the Business and Professions Code) or that he or she is exempt therefrom and the basis for the alleged exemption. Any violation of Section 7031.5 by any applicant for a permit subjects the applicant to a civil penalty of not more than five hundred dollars (\$500.00);

I, as a owner of the property, or my employees with wages as their sole compensation, will do the work, and the structure is not intended or offered for sale (Sec. 7044, Business and Professional Code: The Contractors License Law does not apply to an owner of property who builds or improves thereon, and who does such work himself or herself or through his/her own employees, provided that such improvements are not intended or offered for sale. If, however, the building or improvement is sold within one year of completion, the owner-builder will have the burden of proving that he/she did not build or improve for the purpose of sale.)

I, as owner of the property, am exclusively contracting with licensed contractors to construct the project (Sec. 7044, Business and Professions Code: The Contractors License Law does not apply to an owner of property who builds or improves thereon, and who contracts for such projects with a contractor(s) licensed pursuant to the Contractors License Law).

I am exempt under Sec. _____ B & PC for this reason: _____

Date _____ Owner Signature _____

IN ISSUING THIS BUILDING PERMIT, the applicant represents, and the city relies on the representation of the applicant, that the applicant verified all measurements and locations shown on the application or accompanying drawings and that the improvement to be constructed does not violate any law or private agreement relating to permissible or prohibited locations for such improvements. This building permit does not authorize any illegal location of any improvement or the violation of any private agreement relating to location of improvements.

I certify that I have read this application and state that all information is correct. I agree to comply with all city and county ordinances and state laws relating to building construction and hereby authorize representative(s) of this city to enter upon the abovementioned property for inspection purposes.

Date 3.5.02 Applicant/Agent Signature [Signature]

WORKER'S COMPENSATION DECLARATION: I hereby affirm under penalty of perjury one of the following declarations:

I have and will maintain a certificate of consent to self-insure for workers' compensation as provided for by Section 3700 of the Labor Code, for the performance of work for which the permit is issued.

I have and will maintain workers' compensation insurance, as required by Section 3700 of the Labor Code, for the performance of the work for which this permit is issued. My workers' compensation insurance carrier and policy number are:

Carrier: STATE COMPENSATION INS FUND Policy Number 044-115306-2000 Exp Date 10/02/2002

(This section need not be completed if the permit is for \$100 or less) I certify that in the performance of the work for which this permit is issued, I shall not employ any person in any manner so as to become subject to the workers' compensation laws of California and agree that if I should become subject to the workers' compensation provisions of Section 3700 of the Labor Code, I shall comply with those provisions.

Date 3.5.02 Applicant Signature [Signature]

WARNING: FAILURE TO SECURE WORKERS COMPENSATION COVERAGE IS UNLAWFUL AND SHALL SUBJECT AN EMPLOYER TO CRIMINAL PENALTIES AND CIVIL FINES UP TO ONE HUNDRED THOUSAND DOLLARS (\$100,000) IN ADDITION TO THE COST OF COMPENSATION, DAMAGES AS PROVIDED FOR IN SECTION 3706 OF THE LABOR CODE, INTEREST AND ATTORNEYS FEE.

THIS PERMIT SHALL EXPIRE BY LIMITATION IF WORK IS NOT COMMENCED WITHIN 180 DAYS.

0200247

LOUIS F. BUTZ
Civil Engineer

1650 SILICA AVENUE, SACRAMENTO, CA. 95815
916-649-0177 Fax 916-649-2605

July 2001

ISSUED

JAN 08 2002

Sacramento Building Division

Repairs for River Glen Apartments
Azevado Street

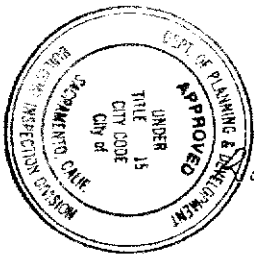

SHALL NOT be held to permit or approve the violation of any City Ordinance or State Law.

This set of plans and specifications must be kept on the job at all times and it is unlawful to make any changes or alterations from the same without written permission from the Building Inspection Division.

Problem is rotted 8x8 posts for stairs and repair to cut off bottom 1' to 2' of post and insert a new section. The load on these 8" x 8" posts is minimal.

Solution is to saw off damaged section at a right angle and place a new section. The new section shall be tied with a 1/4" x 2" plate 12" Long with 3/8" holes drilled at 1" and 4" from each end. Center trap on joint and secure with 3/8" x 3" Lag screws 4 each in each strap. Straps should be centered on All Four sides of each 8" x 8" post.

All Posts are Full size Rough Sawn

ISSUED

AUG 03 2001

Sacramento Building Division

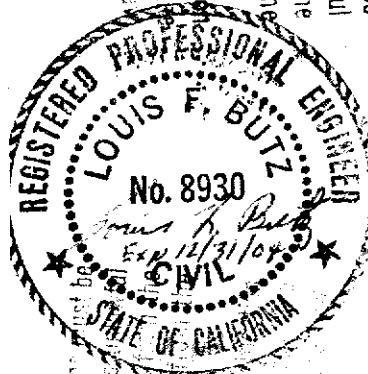

This set of plans and specifications must be kept on the job at all times and it is unlawful to make any changes or alterations from the same without written permission from the Building Inspection Division.

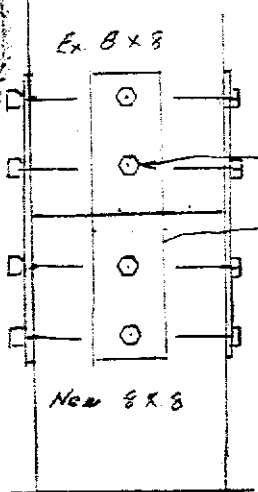

In the event the cut is not True place Tapered shims in the joint to assure uniform bearing.

where long 8x8 posts below balconies are to be replaced use 1/2" plate to extend 2" beyond post and Lag with 2 - 3/8" x 3" Lag screws to beams above. Weld on 1/8" thick x 6" plate to extend down onto outside of 8x8 and secure with 3 - 12Gax 2" screws. Posts and Beams are Full size Rough Sawn

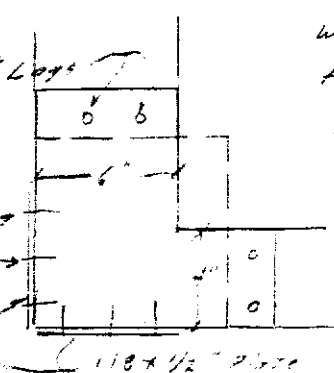

Bryon Nakashin

Stairway

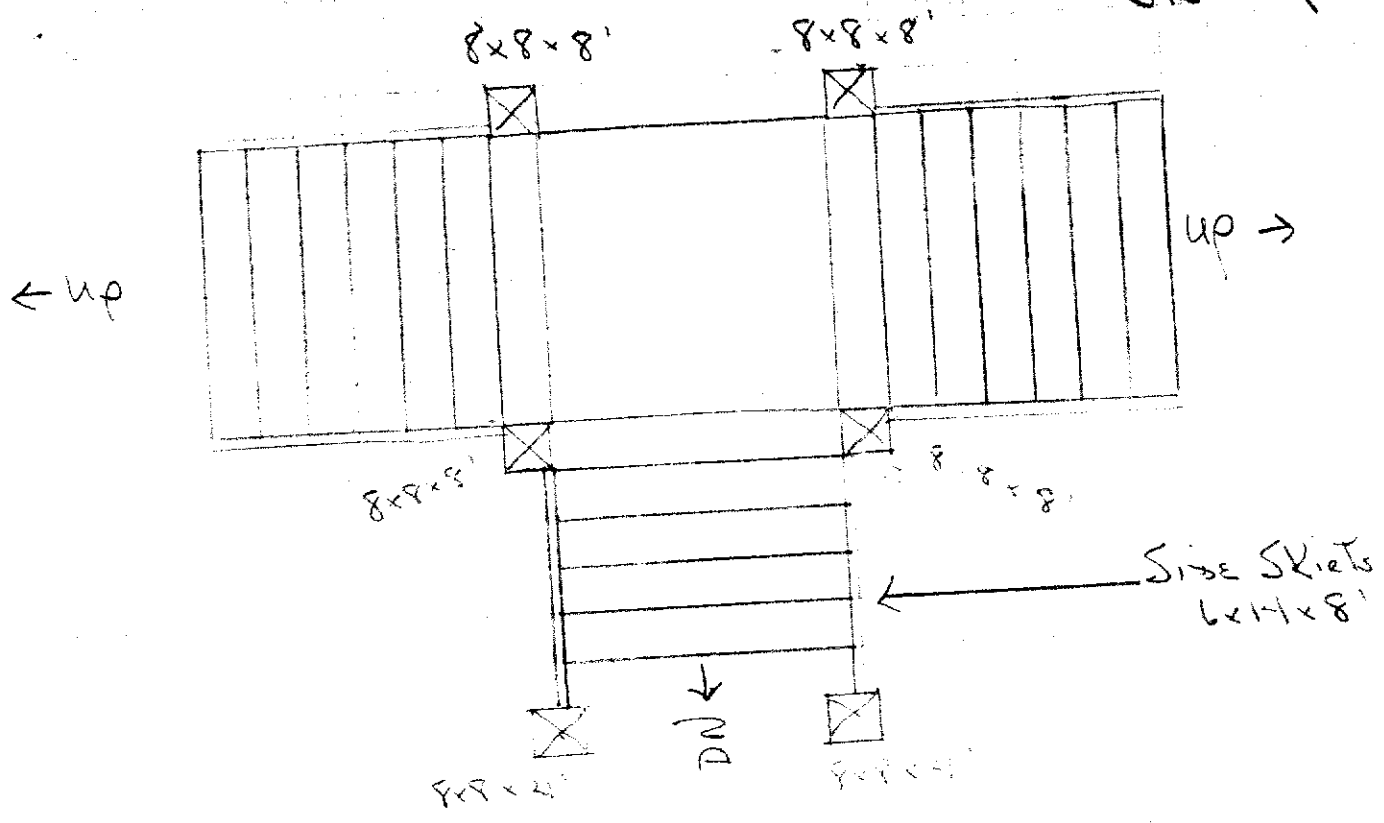

- 1) Primary Repair of 8x8 Vertical Supports and Side Skirts
- 2) minor Repair of Handrails & Fence Boards and adjacent trim

ISSUED
 JAN 08 2002
 Sacramento Building Division

Lumber Grade Douglas fir # 2
 or better



This set of plans and specifications must be kept on the job at all times and it is unlawful to make any changes or alterations from the same without written permission from the Building Inspection Division.
 The approval of this plan and specification SHALL NOT be held to permit or approve the violation of any City Ordinance or State Law.

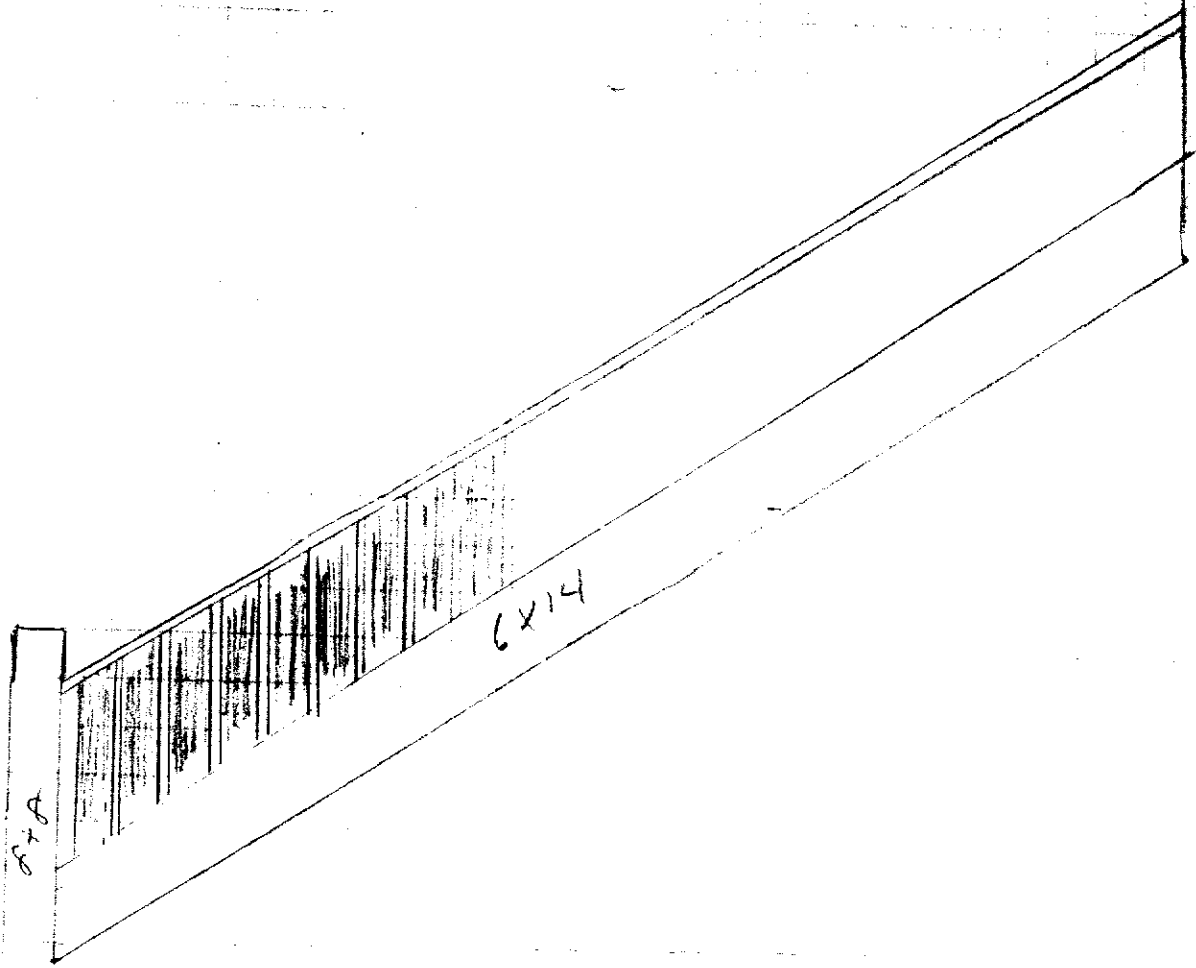

- 1) Repair and or Replacement of 8x8 end rail
- 2) Misc Repair of wicket trim

This set of plans and specifications...

Sacramento Building Division

JAN 08 2002

ISSUED

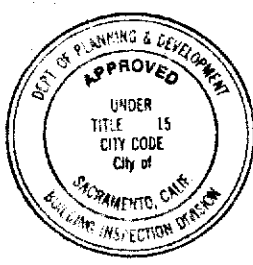

This set of plans and specifications must be kept on the job at all times and it is unlawful to make any changes or alterations from the same without written permission from the Building Inspection Division.

The approval of this plan and specification SHALL NOT be held to permit or approve the violation of any City Ordinance or State Law.