

CITY OF SACRAMENTO

Permit No: 0314215

1231 I Street, Sacramento, CA 95814

Insp Area: 4  
Thos Bros: 257 E6

Site Address: 5101 KENMAR RD SAC  
Parcel No: 226-0034-004

Sub-Type: NGAR  
Housing (Y/N): N

CONTRACTOR

OWNER  
GEORGE AND ROSETTA ATKINS  
5101 KENMAR RD  
SAC CA 95835

ARCHITECT

Nature of Work: 900 SF NEW DETACHED GARAGE

CONSTRUCTION LENDING AGENCY: I hereby affirm under penalty of perjury that there is a construction lending agency for the performance of the work for which this permit is issued (Sec. 3097, Civ. C).

Lender's Name \_\_\_\_\_ Lender's Address \_\_\_\_\_

LICENSED CONTRACTORS DECLARATION: I hereby affirm under penalty of perjury that I am licensed under provisions of Chapter 9 (commencing with section 7000) of Division 3 of the Business and Professions Code and my license is in full force and effect.

License Class \_\_\_\_\_ License Number \_\_\_\_\_ Date \_\_\_\_\_ Contractor Signature \_\_\_\_\_

OWNER-BUILDER DECLARATION: I hereby affirm under penalty of perjury that I am exempt from the contractors License Law for the following reason (Sec. 7031.5, Business and Professions Code; any city or county which requires a permit to construct, alter, improve, demolish, or repair any structure, prior to its issuance, also requires the applicant for such permit to file a signed statement that he or she is licensed pursuant to the provisions of the Contractors License Law (Chapter 9 (commencing with Section 7000) of Division 8 of the Business and Professions Code) or that he or she is exempt therefrom and the basis for the alleged exemption. Any violation of Section 7031.5 by any applicant for a permit subjects the applicant to a civil penalty of not more than five hundred dollars (\$500.00);

I, as a owner of the property, or my employees with wages as their sole compensation, will do the work, and the structure is not intended or offered for sale (Sec. 7044, Business and Professional Code: The Contractors License Law does not apply to an owner of property who builds or improves thereon, and who does such work himself or herself or through his/her own employees, provided that such improvements are not intended or offered for sale. If, however, the building or improvement is sold within one year of completion, the owner-builder will have the burden of proving that he/she did not build or improve for the purpose of sale.)

I, as owner of the property, am exclusively contracting with licensed contractors to construct the project (Sec. 7044, Business and Professions Code: The Contractors License Law does not apply to an owner of property who builds or improves thereon, and who contracts for such projects with a contractor(s) licensed pursuant to the Contractors License Law).

I am exempt under Sec. \_\_\_\_\_ B & PC for this reason: \_\_\_\_\_

Date 9-17-03 Owner Signature *George Atkins*

IN ISSUING THIS BUILDING PERMIT, the applicant represents, and the city relies on the representation of the applicant, that the applicant verified all measurements and locations shown on the application or accompanying drawings and that the improvement to be constructed does not violate any law or private agreement relating to permissible or prohibited locations for such improvements. This building permit does not authorize any illegal location of any improvement or the violation of any private agreement relating to location of improvements.

I certify that I have read this application and state that all information is correct. I agree to comply with all city and county ordinances and state laws relating to building construction and hereby authorize representative(s) of this city to enter upon the abovementioned property for inspection purposes.

Date 9-17-03 Applicant/Agent Signature *George Atkins*

WORKER'S COMPENSATION DECLARATION: I hereby affirm under penalty of perjury one of the following declarations:  
I have and will maintain a certificate of consent to self-insure for workers' compensation as provided for by Section 3700 of the Labor Code, for the performance of work for which the permit is issued.

I have and will maintain workers' compensation insurance, as required by Section 3700 of the Labor Code, for the performance of the work for which this permit is issued. My workers' compensation insurance carrier and policy number are:

Carrier \_\_\_\_\_ Policy Number \_\_\_\_\_ Exp Date \_\_\_\_\_

(This section need not be completed if the permit is for \$100 or less) I certify that in the performance of the work for which this permit is issued, I shall not employ any person in any manner so as to become subject to the workers' compensation laws of California and agree that if I should become subject to the workers' compensation provisions of Section 3700 of the Labor Code, I shall forthwith comply with those provisions.

Date 9-17-03 Applicant Signature *George Atkins*

WARNING: FAILURE TO SECURE WORKER'S COMPENSATION COVERAGE IS UNLAWFUL AND SHALL SUBJECT AN EMPLOYER TO CRIMINAL PENALTIES AND CIVIL FINES UP TO ONE HUNDRED THOUSAND DOLLARS (\$100,000) IN ADDITION TO THE COST OF COMPENSATION, DAMAGES AS PROVIDED FOR IN SECTION 3706 OF THE LABOR CODE, INTEREST AND ATTORNEY'S FEE.

THIS PERMIT SHALL EXPIRE BY LIMITATION IF WORK IS NOT COMMENCED WITHIN 180 DAYS.

City of Sacramento Planning Division  
**PLANNING REVIEW FOR BUILDING PERMIT SUBMITTAL**

ADDRESS: 5101 Kenmar Road	APN: 226-0034-004
DRPB AREA / PUD / SPD: Expanded North Area	ZONING: RE 1/1
EXISTING LAND USE: SFR w/ no garage	
PROPOSED USE: Detached side-entry garage in front and to the side of house	
<b>PLANNING STAFF WILL CHECK ONE OR MORE OF THE ITEMS BELOW:</b>	
<input type="checkbox"/>	Use is <b>NOT</b> allowed; applicant <b>CANNOT</b> submit for plan check.
<input type="checkbox"/>	Requires <b>APPLICATION(s)</b> :    PC            ZA            IR            ER            DR            PB Required Planning application must be submitted <i>before</i> project can be submitted for plan check.
<input type="checkbox"/>	<b>Application(s) IN PROGRESS:</b> Applicant may submit for concurrent building permit plan check, at applicant's risk. Building Division must check with Planning staff and/or <b>SITE</b> before issuing building permit.
<input checked="" type="checkbox"/>	<b>Application(s) COMPLETED:</b> ER03-200 approved 9/17/03 OTC Building permit must conform to approved plans and comply with all conditions of approval. Do <b>NOT</b> issue building permit prior to end of 10 day appeal period.
<input checked="" type="checkbox"/>	<b>Plans may be submitted for plan check.</b> Plan checker(s) shall confirm compliance with Zoning Ordinance requirements and all applicable development standards <i>prior to issuance</i> of building permit.
<input checked="" type="checkbox"/>	Meets setback & lot coverage requirements as shown on site plan provided.
<input checked="" type="checkbox"/>	Plans to be submitted have been stamped/signed by Planning counter staff.
<input type="checkbox"/>	<b>Route to SITE</b> for plan check and inspection.
<input type="checkbox"/>	Preliminary review <b>ONLY</b> ; the information on this form <b>must be reviewed again and confirmed</b> at the time of building permit submittal.
COMMENTS: Must comply with approved ER checklist attached to plans submitted	
DATE: 9/17/03	BY: Phil Reed 

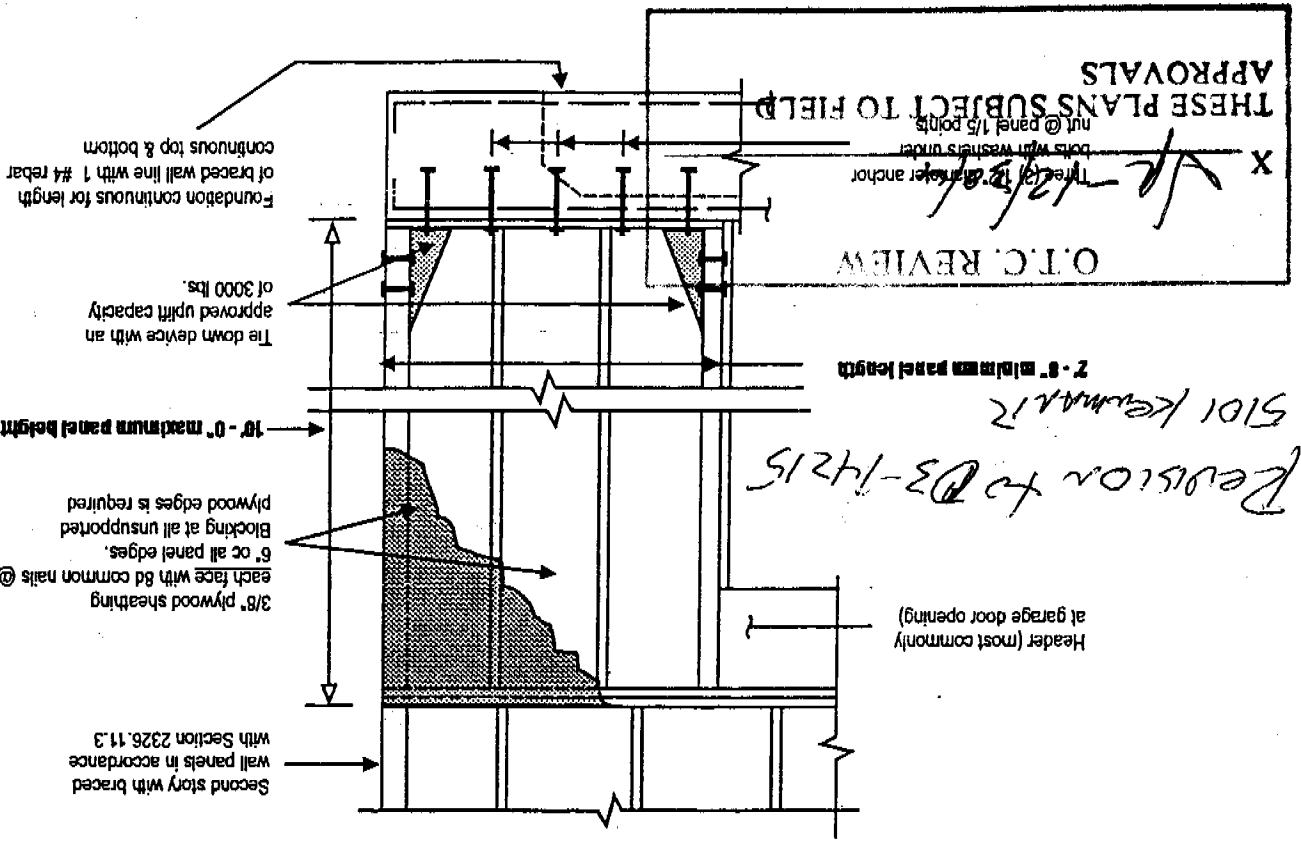

**ALTERNATE BRACED WALL PANEL AT FIRST STORY OF A TWO STORY BUILDING**

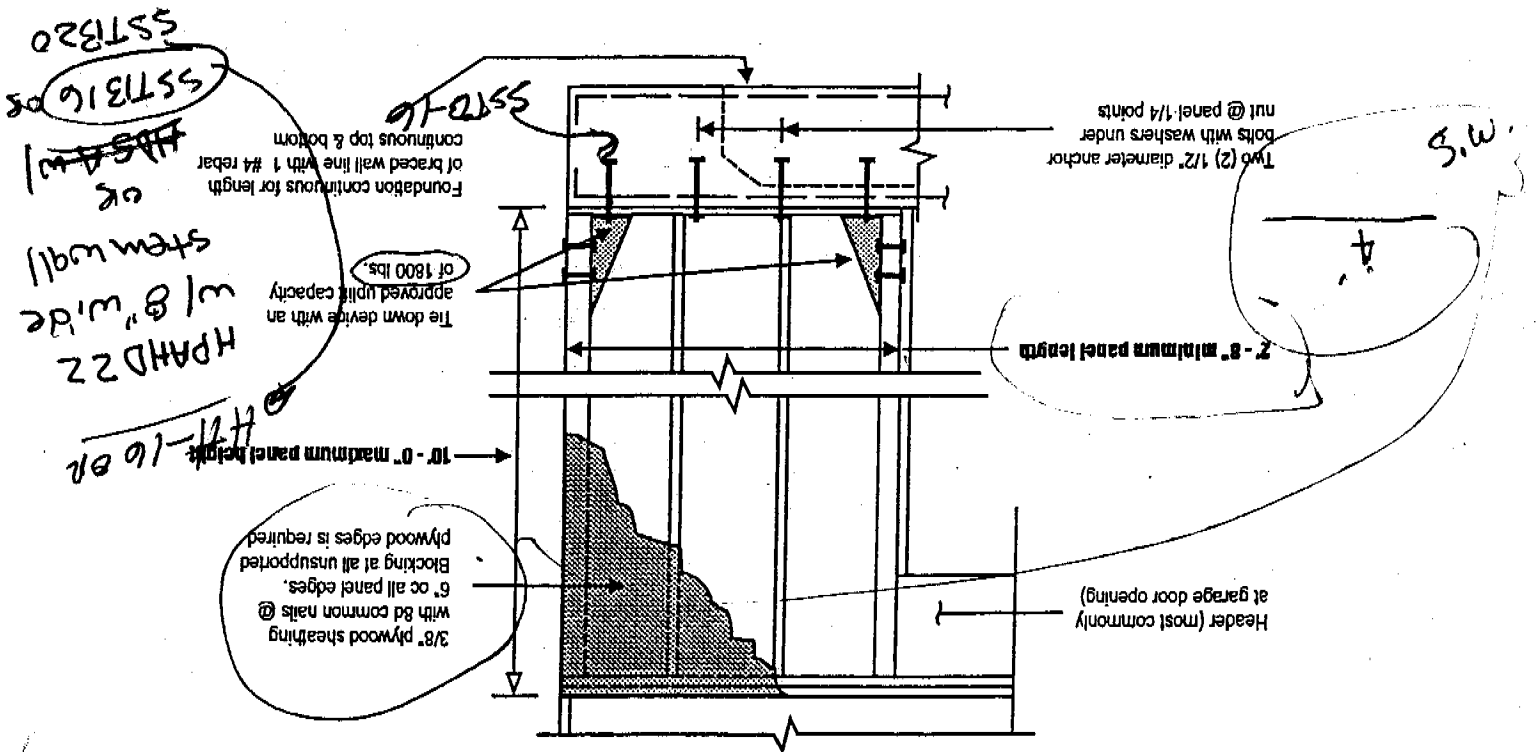

**\* ALTERNATE BRACED WALL PANEL AT ONE STORY BUILDING**



# CITY OF SACRAMENTO RE-ROOF PERMIT DESIGN REVIEW GUIDE

## COMPOSITION ROOFING MATERIALS

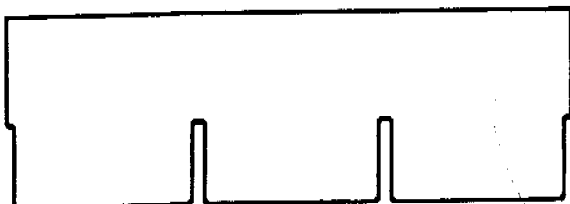

Three-tab NOT ALLOWED  
in Design Review Areas

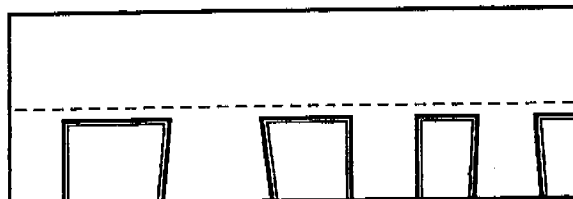

Laminated Dimensional  
minimum 30-year required

## GUTTER TYPES

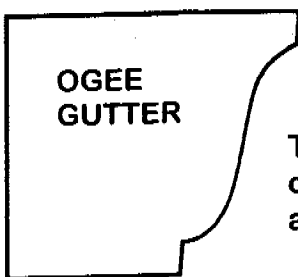

OGEE  
GUTTER

Typical of  
older style  
architecture

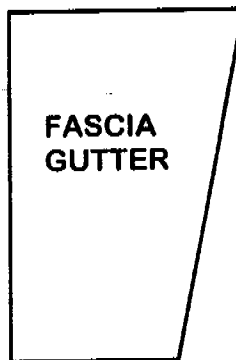

FASCIA  
GUTTER

Typical of  
newer 'modern'  
architecture

## RAFTER TAILS

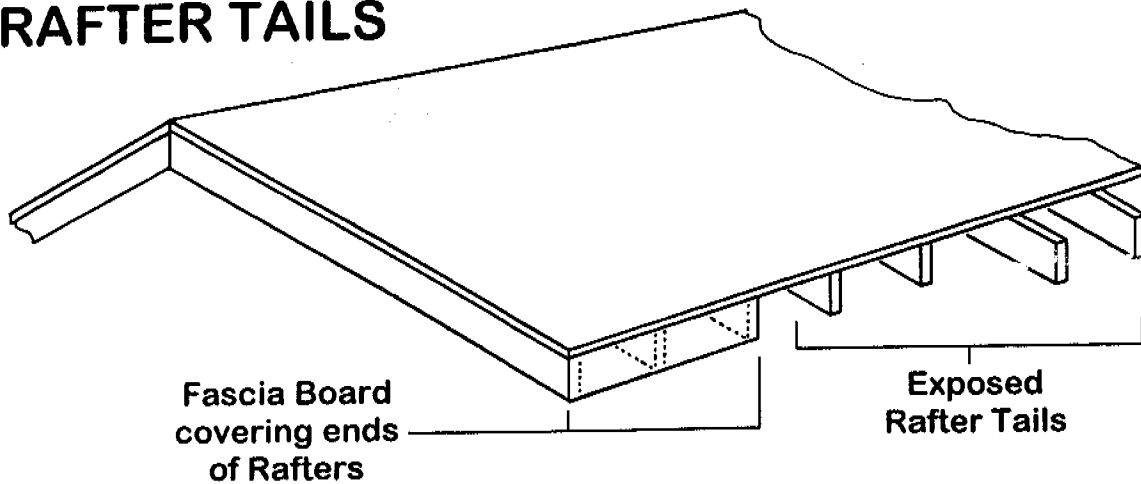

Fascia Board  
covering ends  
of Rafters

Exposed  
Rafter Tails