

CITY OF SACRAMENTO

1231 I Street, Sacramento, CA 95814

Permit No: 0403780

Insp Area: 2

Thos Bros: 316G7

Site Address: 23 NAUTILUS CT SAC

Parcel No: 030-0740-010

Sub-Type: RES

Housing (Y/N): N

CONTRACTOR

ZIMMERMAN REROOFING CO.
3675 R ST
SACRAMENTO CA 95816

OWNER

KENNETH & STACEY OKINO
23 NAUTILUS CT
SACRAMENTO CA 95831

ARCHITECT

Nature of Work: TEAR OFF, RESHEET & REROOF 38 SQ LT WT CONC TILE FOR SFR W/
GAR

CONSTRUCTION LENDING AGENCY : I hereby affirm under penalty of perjury that there is a construction lending agency for the performance of the work for which this permit is issued (Sec. 3097, Civ. C).

Lender's Name _____ Lender's Address _____

LICENSED CONTRACTORS DECLARATION: I hereby affirm under penalty of perjury that I am licensed under provisions of Chapter 9 (commencing with section 7000) of Division 3 of the Business and Professions Code and my license is in full force and effect.

License Class C-39 License Number 763169 Date 3/25/04 Contractor Signature Kate Orp

OWNER-BUILDER DECLARATION: I hereby affirm under penalty of perjury that I am exempt from the contractors License Law for the following reason (Sec. 7031.5, Business and Professions Code; any city or county which requires a permit to construct, alter, improve, demolish, or repair any structure, prior to its issuance, also requires the applicant for such permit to file a signed statement that he or she is licensed pursuant to the provisions of the Contractors License Law (Chapter 9 (commencing with Section 7000) of Division 8 of the Business and Professions Code) or that he or she is exempt therefrom and the basis for the alleged exemption. Any violation of Section 7031.5 by any applicant for a permit subjects the applicant to a civil penalty of not more than five hundred dollars (\$500.00);

I, as a owner of the property, or my employees with wages as their sole compensation, will do the work, and the structure is not intended or offered for sale (Sec. 7044, Business and Professional Code: The Contractors License Law does not apply to an owner of property who builds or improves thereon, and who does such work himself or herself or through his/her own employees, provided that such improvements are not intended or offered for sale. If, however, the building or improvement is sold within one year of completion, the owner-builder will have the burden of proving that he/she did not build or improve for the purpose of sale.)

I, as owner of the property, am exclusively contracting with licensed contractors to construct the project (Sec. 7044, Business and Professions Code: The Contractors License Law does not apply to an owner of property who builds or improves thereon, and who contracts for such projects with a contractor(s) licensed pursuant to the Contractors License Law).

I am exempt under Sec. _____ B & PC for this reason: _____

Date _____ Owner Signature _____

IN ISSUING THIS BUILDING PERMIT, the applicant represents, and the city relies on the representation of the applicant, that the applicant verified all measurements and locations shown on the application or accompanying drawings and that the improvement to be constructed does not violate any law or private agreement relating to permissible or prohibited locations for such improvements. This building permit does not authorize any illegal location of any improvement or the violation of any private agreement relating to location of improvements.

I certify that I have read this application and state that all information is correct. I agree to comply with all city and county ordinances and state laws relating to building construction and hereby authorize representative(s) of this city to enter upon the abovementioned property for inspection purposes.

Date 3/25/04 Applicant/Agent Signature Kate Orp

WORKER'S COMPENSATION DECLARATION: I hereby affirm under penalty of perjury one of the following declarations:

I have and will maintain a certificate of consent to self-insure for workers' compensation as provided for by Section 3700 of the Labor Code, for the performance of work for which the permit is issued.

KO I have and will maintain workers' compensation insurance, as required by Section 3700 of the Labor Code, for the performance of the work for which this permit is issued. My workers' compensation insurance carrier and policy number are:

Carrier STATE FUND Policy Number 713-0002021 Exp Date 10/01/2004

(This section need not be completed if the permit is for \$100 or less) I certify that in the performance of the work for which this permit is issued, I shall not employ any person in any manner so as to become subject to the workers' compensation laws of California and agree that if I shall become subject to the workers' compensation provisions of Section 3700 of the Labor Code, I shall forthwith comply with those provisions.

Date 3/25/04 Applicant Signature Kate Orp

WARNING: FAILURE TO SECURE WORKER'S COMPENSATION COVERAGE IS UNLAWFUL AND SHALL SUBJECT AN EMPLOYER TO CRIMINAL PENALTIES AND CIVIL FINES UP TO ONE HUNDRED THOUSAND DOLLARS (\$100,000) IN ADDITION TO THE COST OF COMPENSATION, DAMAGES AS PROVIDED FOR IN SECTION 3706 OF THE LABOR CODE, INTEREST AND ATTORNEY'S FEE.

THIS PERMIT SHALL EXPIRE BY LIMITATION IF WORK IS NOT COMMENCED WITHIN 180 DAYS.

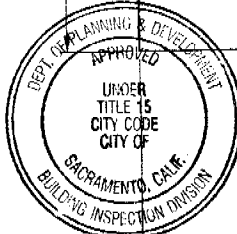
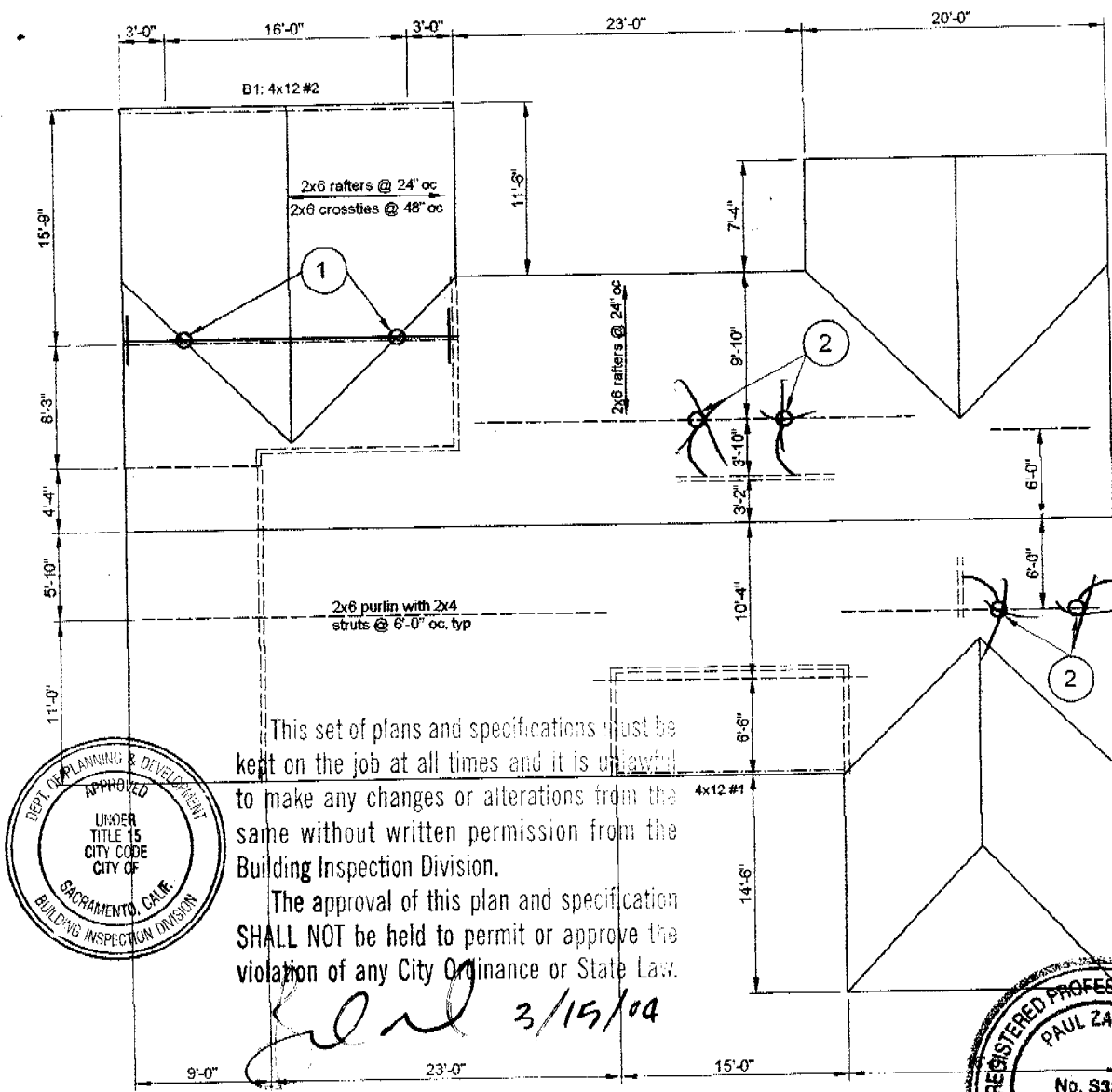

This set of plans and specifications must be kept on the job at all times and it is unlawful to make any changes or alterations from the same without written permission from the Building Inspection Division. The approval of this plan and specification SHALL NOT be held to permit or approve the violation of any City Ordinance or State Law.

[Handwritten signature] 3/15/04

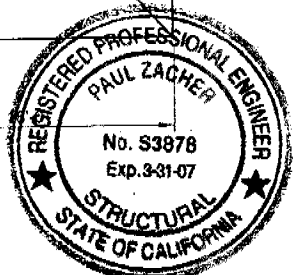

FRAMING NOTES:

1. Scab a 1-3/4" x 11-7/8" LVL to the existing 2x6 crossie with 16d's @ 6" oc. The support at the interior wall shall be a 2x8 x 2'-8" long ledger attached to the double top plate with 16d's @ 2" oc staggered. Support the existing valley rafters to the LVL below with 2x4 struts. See detail 2.
- X Add 2x4 struts to bearing below (total 4).

[Handwritten signature] SPB 5-4-04

NOTES:

- A. This is a reroof project. The new roofing material shall be a Light Weight Concrete Tile. The tile shall weigh less than or equal to 7.3 psf.
- B. All rafters are 2x6 DF#2 and hips and valleys are 2x8 DF#2 unless otherwise noted.
- C. All existing rafter, hips, valleys, rafter ties, and purlins are braced per UBC Section 2320.1 "Roof and Ceiling Framing" unless otherwise shown.
- D. All structural wood members that were observed appear to be in sound condition and without structural defect.

1 **ROOF PLAN - OKINO**
Not to Scale
[Handwritten number 6]

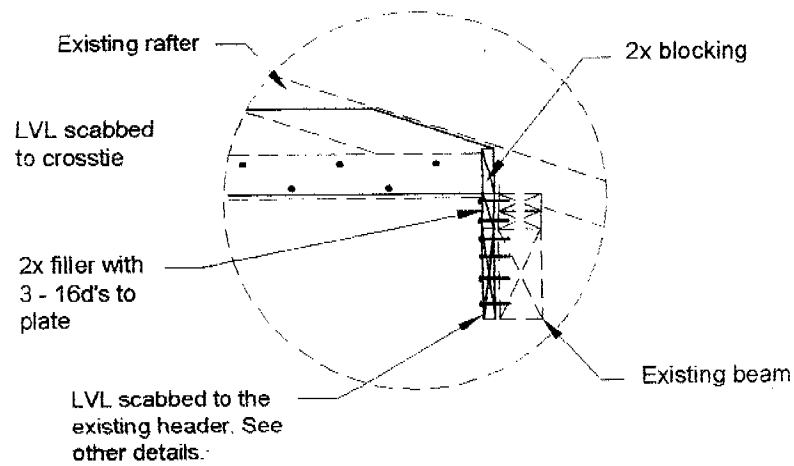

ALTERNATE CONNECTION AT BEAM

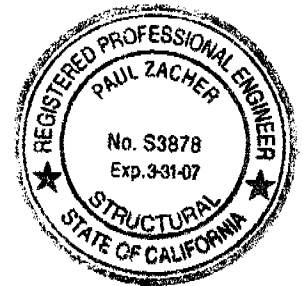
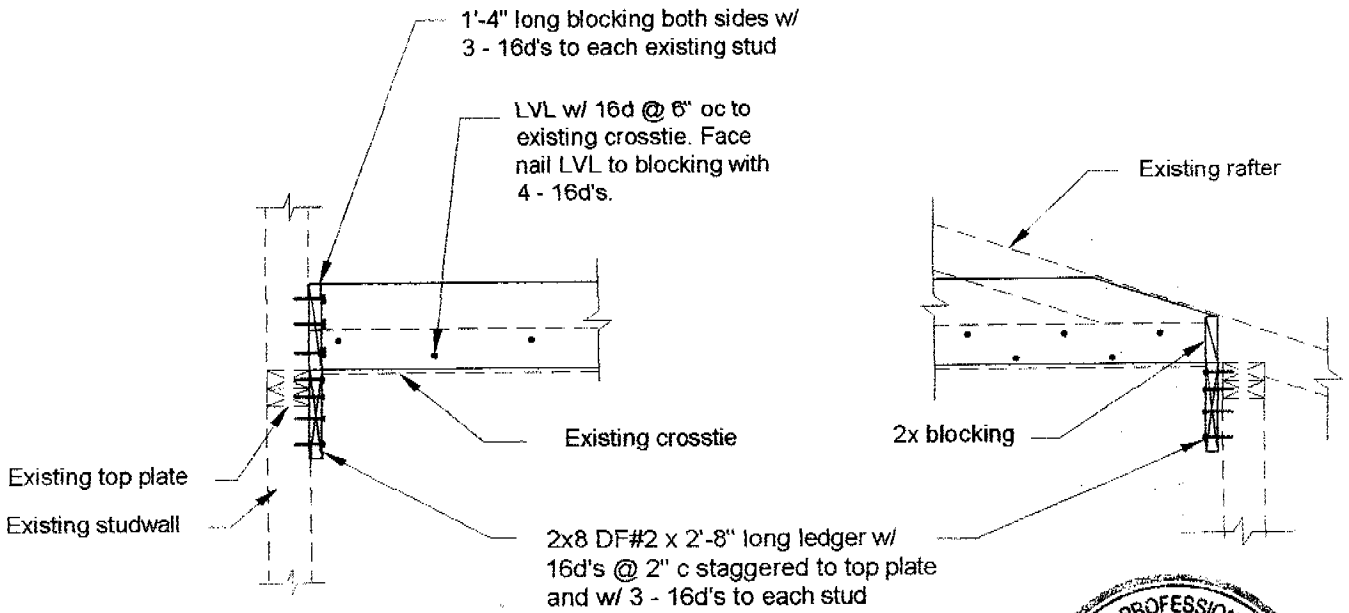

2

LEDGER CONNECTION

scale: 1/2" = 1'-0"

Okino



Paul Zacher - Structural Engineers, Inc
4701 Lakeside Way
Fair Oaks, CA 95628

TEL: 916.961.3960
FAX: 916.961.6552

March 4, 2004

Zimmerman Roofing
3675 R Street
Sacramento, CA 95816
TEL: (916) 454-3667
FAX: (916) 691-1943

Attn.: Mr. Jeff Tucker,

re: Job 2004086: OKINO

Subject: Structural Investigation Report of the Roof for the Residence located at 123 Nautilus Court,
Sacramento, CA 95831.

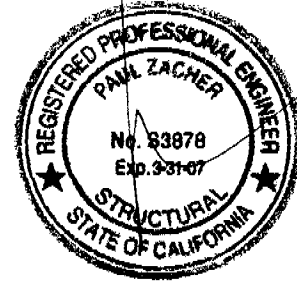

As requested by Mr. Jeff Tucker, this is a report to determine what needs should be addressed to correct any structural deficiencies of the roof. Paul Zacher visited the site March 4, 2004. The investigation was made to determine the existing condition of the structure. All information, data and analysis contained within this report are based on the 1997 Uniform Building Code with 2001 CBC Title 24 Amendments.

The following is based on visual observations with no subsurface investigation being made.

DESCRIPTION:

Type of Facility: Residence.
Year Built: Estimated 1980's vintage.
Occupancy: Residential.
No. of Stories: One.
Dimensions: Approximately 3000 square feet.

CONSTRUCTION:

Roof:
The roof covering will consist of a Light Weight Concrete Tile over 7/16" solid sheathing. The roof structure is conventionally framed with 2x6 rafters spaced at 24" on center with 2x6 purlins supported at no more than 8'-0" on center by 2x4 struts bearing on walls below. The garage area is framed with 2x6 rafters spaced at 24" on center and 2x6 cross ties spaced at 4'-0" on center.

CONCLUSIONS:

Roof:
The roof structure currently lacks sufficient structural capacity for the applied live and dead loads. See "Recommendations" for location and repair to bring the roof structure up to the required capacity.

Okino



Paul Zacher - Structural Engineers, Inc
4701 Lakeside Way
Fair Oaks, CA 95628

TEL: 916.961.3960
FAX: 916.961.6552

RECOMMENDATIONS:

If any of the following recommendations do not correspond to actual field conditions, the engineer of record shall be notified for further investigation and evaluation before continuing work.

1. Scab a 1 3/4" x 11 7/8" LVL beam to the existing 2x6 crosstie and nail together with 16d's @ 6" oc. The support at the wall shall be a 2x8 x 2'-8" long ledger attached to the double top plate with 16d's @ 2" oc staggered. Support the existing valley rafter to the LVL beam with 2x4 strut. See details 1 and 2.
2. Provide additional 2x4 struts from the existing purlins to the bearing walls below. The maximum spacing between the new and existing struts shall not exceed 6'-0" on center. The unbraced length of the struts shall not exceed 8'-0" and the minimum slope of the struts shall not be less than 45 degrees from the horizontal. See detail 1.

It shall be noted that small hairline cracking may occur at exterior stucco and interior gypboard finished walls that are load bearing or distributing roof strut loads. These cracks are a natural occurrence as the existing structure re-distributes the new roof weight. They are cosmetic in nature and are not an indication of a structural hazard or failure.

It shall be noted that some deflection of the rafters may be evident after installation of the tile. The existing roof framing has deflected but this may not be readily evident due to the uneven nature of the existing roofing material. Concrete tile is a very consistent and uniform product and when installed in an even plane, even small deflections can become apparent. This is only a cosmetic issue and not a structural concern.

The inspection consisted of visual observation only, made solely to determine the structural capacity of the existing roof. Analysis does not determine any effects on the overall structure under lateral forces or effects on the foundation unless specifically noted in the calculations and in this document. No warranties, expressed or implied, are made or intended in conjunction with this report. The inspection was made only to the portions that were accessible. The specific items noted were those that were observable and there may be defects that are not observable, or are hidden by architectural and structural materials.

If you have any questions on the above, do not hesitate to call.

Sincerely,

Paul Zacher, P.E., S.E.
file

DESIGN LOADING:

Roof Pitch	6	in 12
Pitch Adjustment Factor	1.12	

LOCATION: ROOF

<u>MATERIAL</u>	<u>WEIGHT</u>	
Light Weight Tile	7.30	psf
Roofing felt	0.30	psf
1x4 skip sht'g	1.09	psf
7/16" OSB/ plywood	1.30	psf
2x6 rafters @ 24" oc	<u>1.00</u>	psf
	Load	11.0 psf
Roof Pitch Adjustment	<u>1.30</u>	psf
Total Load	12.3	psf

Job #: 04_086
Date: 03/04/2004

LOADING:

Rafter:

24.6 / 32.0

Dr = 12.3 psf x 2'-0" = 24.6 plf
Lr = 16.0 psf x 2'-0" = 32.0 plf

2x6 #2

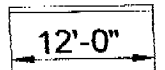

B1:

62 / 80

Dr = 12.3 psf x 5'-0" = 62 plf
Lr = 16.0 psf x 5'-0" = 80 plf

4x12 #2

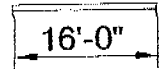

LVL:

Pdr = 12.3 psf x 5' x 5' = 308 lbs
Plr = 16.0 psf x 5' x 5' = 400 plf

1-3/4"x11 7/8" LVL

603 / 784

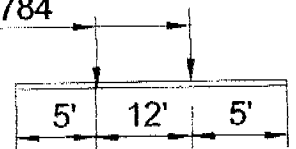

Paul Zacher - Structural Engr's
 4701 Lakeside Way
 Fair Oaks, CA 95628
 TEL: (916) 961-3960
 FAX: (916) 961-6552

Title :
 Dsgnr:
 Description :

Job #
 Date: 12:12PM, 5 MAR 04

Scope :

Rev: 560100
 User: KW-0602644, Ver 5.6.1, 25-Oct-2002
 (c)1983-2002 ENERCALC Engineering Software

Timber Beam & Joist

c:\documents and settings\paul.zacher\desktop

Description RAFTERS AND BEAMS

Timber Member Information Calculations are designed to 1997 NDS and 1997 UBC Requirements

Timber Section		rafter 2x6	B1 4x12	LVL MicroLam:
Beam Width	in	1.500	3.500	1.750
Beam Depth	in	5.500	11.250	11.875
Le: Unbraced Length	ft	0.00	0.00	0.00
Timber Grade		Douglas Fir - Larch	Douglas Fir - Larch	Truss Joist - MacMil
Fb - Basic Allow	psi	875.0	875.0	2,600.0
Fv - Basic Allow	psi	95.0	95.0	285.0
Elastic Modulus	ksi	1,600.0	1,600.0	1,900.0
Load Duration Factor		1.250	1.250	1.250
Member Type		Sawn	Sawn	Manuf/Pine
Repetitive Status		Repetitive	No	No

Center Span Data

	ft	12.00	16.00	22.00
Span	ft	12.00	16.00	22.00
Dead Load	#/ft	24.60	62.00	
Live Load	#/ft	32.00	80.00	
Point #1 DL	lbs			603.00
LL	lbs			784.00
@ X	ft			5.000
Point #2 DL	lbs			603.00
LL	lbs			784.00
@ X	ft			17.000

Results Ratio = 0.9887 0.6139 0.6226

	in-k	12.23	54.53	83.22
Mmax @ Center	in-k	12.23	54.53	83.22
@ X =	ft	6.00	8.00	5.02
fb : Actual	psi	1,616.6	738.6	2,023.4
Fb : Allowable	psi	1,635.2	1,203.1	3,250.0
		Bending OK	Bending OK	Bending OK
fv : Actual	psi	57.3	38.4	100.1
Fv : Allowable	psi	118.8	118.8	356.3
		Shear OK	Shear OK	Shear OK

Reactions

	lbs	147.60	496.00	603.00
@ Left End DL	lbs	147.60	496.00	603.00
LL	lbs	192.00	640.00	784.00
Max. DL+LL	lbs	339.60	1,136.00	1,387.00
@ Right End DL	lbs	147.60	496.00	603.00
LL	lbs	192.00	640.00	784.00
Max. DL+LL	lbs	339.60	1,136.00	1,387.00

Deflections Ratio OK Deflection OK Deflection OK

	in	-0.345	-0.138	-0.633
Center DL Defl	in	-0.345	-0.138	-0.633
L/Defl Ratio		417.5	1,395.5	417.4
Center LL Defl	in	-0.449	-0.178	-0.822
L/Defl Ratio		320.9	1,081.5	321.0
Center Total Defl	in	-0.794	-0.315	-1.455
Location	ft	6.000	8.000	11.000
L/Defl Ratio		181.5	609.3	181.5

5