

CITY OF SACRAMENTO

Permit No: 9805687

1231 I Street, Sacramento, CA 95814

Insp Area: 2

Site Address: 2328 66TH AV SAC

Sub-Type: COM

Parcel No: 0470154016

Housing (Y/N): N

CONTRACTOR

OWNER

ARCHITECT

JOHNSON DONALD C/LOLA M
7760 TEEKAY WY
SACRAMENTO CA 95832

Nature of Work: PULL STATION FOR CARE FACILITY

CONSTRUCTION LENDING AGENCY : I hereby affirm under penalty of perjury that there is a construction lending agency for the performance of the work for which this permit is issued (Sec. 3097, Civ. C).

Lender's Name _____ Lender's Address _____

LICENSED CONTRACTORS DECLARATION: I hereby affirm under penalty of perjury that I am licensed under provisions of Chapter 9 (commencing with section 7000) of Division 3 of the Business and Professions Code and my license is in full force and effect.

License Class _____ License Number _____ Date _____ Contractor Signature _____

OWNER-BUILDER DECLARATION: I hereby affirm under penalty of perjury that I am exempt from the contractors License Law for the following reason (Sec. 7031.5, Business and Professions Code; any city or county which requires a permit to construct, alter, improve, demolish, or repair any structure, prior to its issuance, also requires the applicant for such permit to file a signed statement that he or she is licensed pursuant to the provisions of the Contractors License Law (Chapter 9 (commencing with Section 7000) of Division 8 of the Business and Professions Code) or that he or she is exempt therefrom and the basis for the alleged exemption. Any violation of Section 7031.5 by any applicant for a permit subjects the applicant to a civil penalty of not more than five hundred dollars (\$500.00);

____ I, as a owner of the property, or my employees with wages as their sole compensation, will do the work, and the structure is not intended or offered for sale (Sec. 7044, Business and Professional Code: The Contractors License Law does not apply to an owner of property who builds or improves thereon, and who does such work himself or herself or through his/her own employees, provided that such improvements are not intended or offered for sale. If, however, the building or improvement is sold within one year of completion, the owner-builder will have the burden of proving that he/she did not build or improve for the purpose of sale.)

____ I, as owner of the property, am exclusively contracting with licensed contractors to construct the project (Sec. 7044, Business and Professions Code: The Contractors License Law does not apply to an owner of property who builds or improves thereon, and who contracts for such projects with a contractor(s) licensed pursuant to the Contractors License Law).

____ I am exempt under Sec. _____ B & PC for this reason: _____

Date _____ Owner Signature _____

IN ISSUING THIS BUILDING PERMIT, the applicant represents, and the city relies on the representation of the applicant, that the applicant verified all measurements and locations shown on the application or accompanying drawings and that the improvement to be constructed does not violate any law or private agreement relating to permissible or prohibited locations for such improvements. This building permit does not authorize any illegal location of any improvement or the violation of any private agreement relating to location of improvements.

I certify that I have read this application and state that all information is correct. I agree to comply with all city and county ordinances and state laws relating to building construction and hereby authorize representative(s) of this city to enter upon the abovementioned property for inspection purposes.

Date 6-23-98 Applicant/Agent Signature Lola Johnson

WORKER'S COMPENSATION DECLARATION: I hereby affirm under penalty of perjury one of the following declarations:

____ I have and will maintain a certificate of consent to self-insure for workers' compensation as provided for by Section 3700 of the Labor Code, for the performance of work for which the permit is issued.

____ I have and will maintain workers' compensation insurance, as required by Section 3700 of the Labor Code, for the performance of the work for which this permit is issued. My workers' compensation insurance carrier and policy number are:

Carrier No employees Policy Number _____

____ (This section need not be completed if the permit is for \$100 or less) I certify that in the performance of the work for which this permit is issued, I shall not employ any person in any manner so as to become subject to the workers' compensation laws of California and agree that if I should become subject to the workers' compensation provisions of Section 3700 of the Labor Code, I shall forthwith comply with those provisions.

Date 6-23-98 Applicant Signature Lola Johnson

WARNING: FAILURE TO SECURE WORKER'S COMPENSATION COVERAGE IS UNLAWFUL AND SHALL SUBJECT AN EMPLOYER TO CRIMINAL PENALTIES AND CIVIL FINES UP TO ONE HUNDRED THOUSAND DOLLARS (\$100,000) IN ADDITION TO THE COST OF COMPENSATION, DAMAGES AS PROVIDED FOR IN SECTION 3706 OF THE LABOR CODE, INTEREST AND ATTORNEY'S FEE.

THIS PERMIT SHALL EXPIRE BY LIMITATION IF WORK IS NOT COMMENCED WITHIN 180 DAYS.

**CITY OF SACRAMENTO
APPLICATION FOR BUILDING PERMIT**

**DEVELOPMENT SERVICES DIVISION
PERMIT SERVICES DIVISION**

1231 I Street, Rm. 200
Sacramento, CA 95814

(916) 264-7619 FAX 264-7046

→ Applicant must complete ALL Unshaded areas ←

PC #	AREA #
------	--------

ADDRESS 2328 66th Ave Suite _____
PARCEL # 047-0154-016

<p align="center">CONTACT</p> Name _____ Address _____ _____ Zip _____ Phone _____ FAX _____		<p align="center">LICENCED CONTRACTOR Lic No. # _____</p> Name _____ Address _____ _____ Zip _____ Phone _____ FAX _____	
<p align="center">ARCHITECT/ENGINEER</p> Name _____ Address _____ _____ Zip _____ Phone _____ FAX _____		<p align="center">OWNER/TENANT</p> Name <u>NOIA JOHNSON</u> Address <u>2328 66th Ave</u> <u>SACRA CA</u> Zip <u>95822</u> Phone <u>395-2479</u> FAX _____	

→ Will the permittee have any employees on the jobsite? Yes No

→ If yes, WORKER'S COMPENSATION POLICY # _____ EXPIRATION DATE: _____

NAME OF INSURANCE COMPANY: _____

NATURE OF WORK IN DETAIL: Full structural
6 clients Both Ambulatory and Non-ambulatory

DBA: _____ VALUATION: up to 999

FLOOD STATUS:				S.C.A.T.						
JOB DESCRIPTION		BLDG	SHEL	APT	TI()	REM()	SW	FIRE	ADD	OTH
INSP. DISCIPLINES		BLDG	MECH	PLUMB	ELEC	SITE	FIRE			
# Stories	1st flr Area	Total Area	Use Zone	Occp Group	Const type	Fire Req. Y/N		Fed Code	Vio. File	
				<u>R2.1A</u>		Spr	Alarm <u>Y</u>			
B	L	P	M	<u>E</u>	<u>F</u>	S	<u>D</u>	R		

COMMENTS: _____

REGIONAL SANITATION FEES? Yes No HEALTH DEPARTMENT? Yes No

*Identify breaker red,
install lock-on device
for breaker & use
dedicated circuit*

Division of Electrical Work
Field Inspections

*6-23-98
JAN*

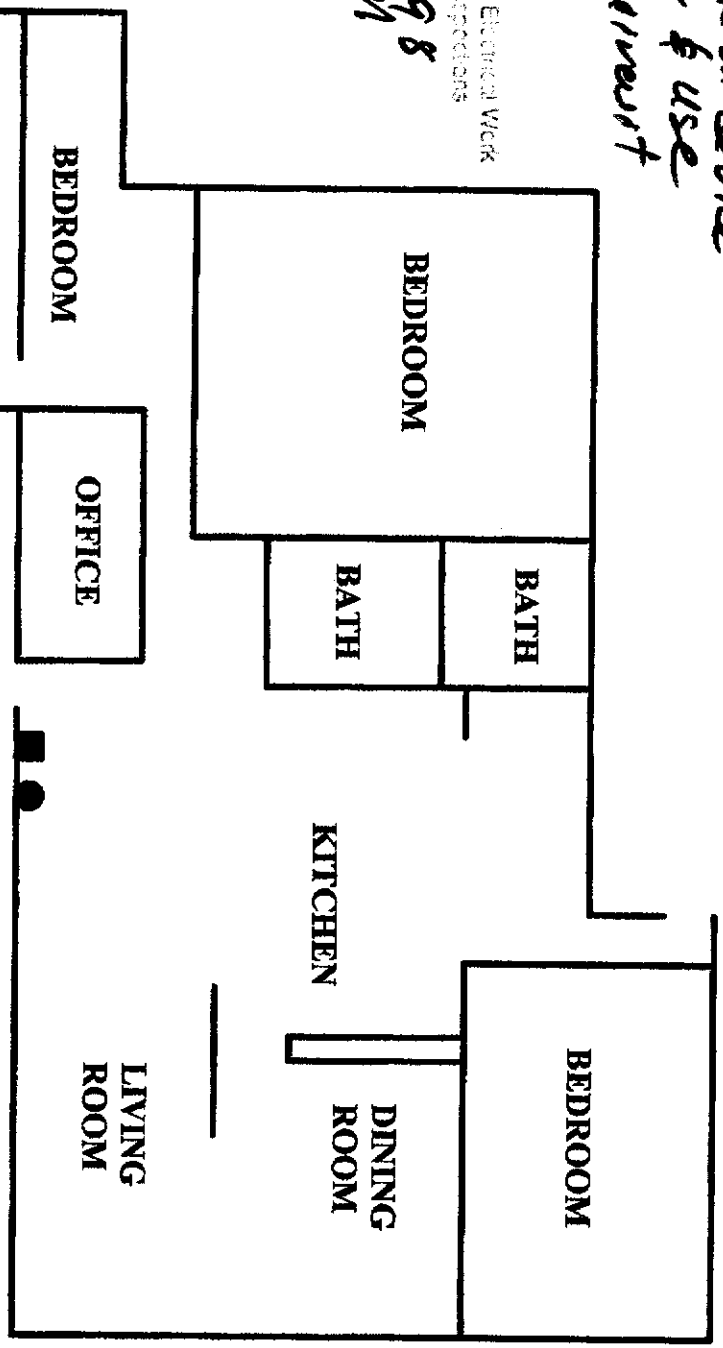

LOLA'S CARE HOME #3
2328 66TH AVENUE
SACRAMENTO, CA., 95822

Max. 6 Nonambulatory Clients

ISSUED

JUN 23 1998

LEGEND

- = MANUAL PULL STATION
- = 120 VAC 6" FIRE BELL

APPROVED
S.H. Clark
SACRAMENTO
FIRE DEPARTMENT

9805687c

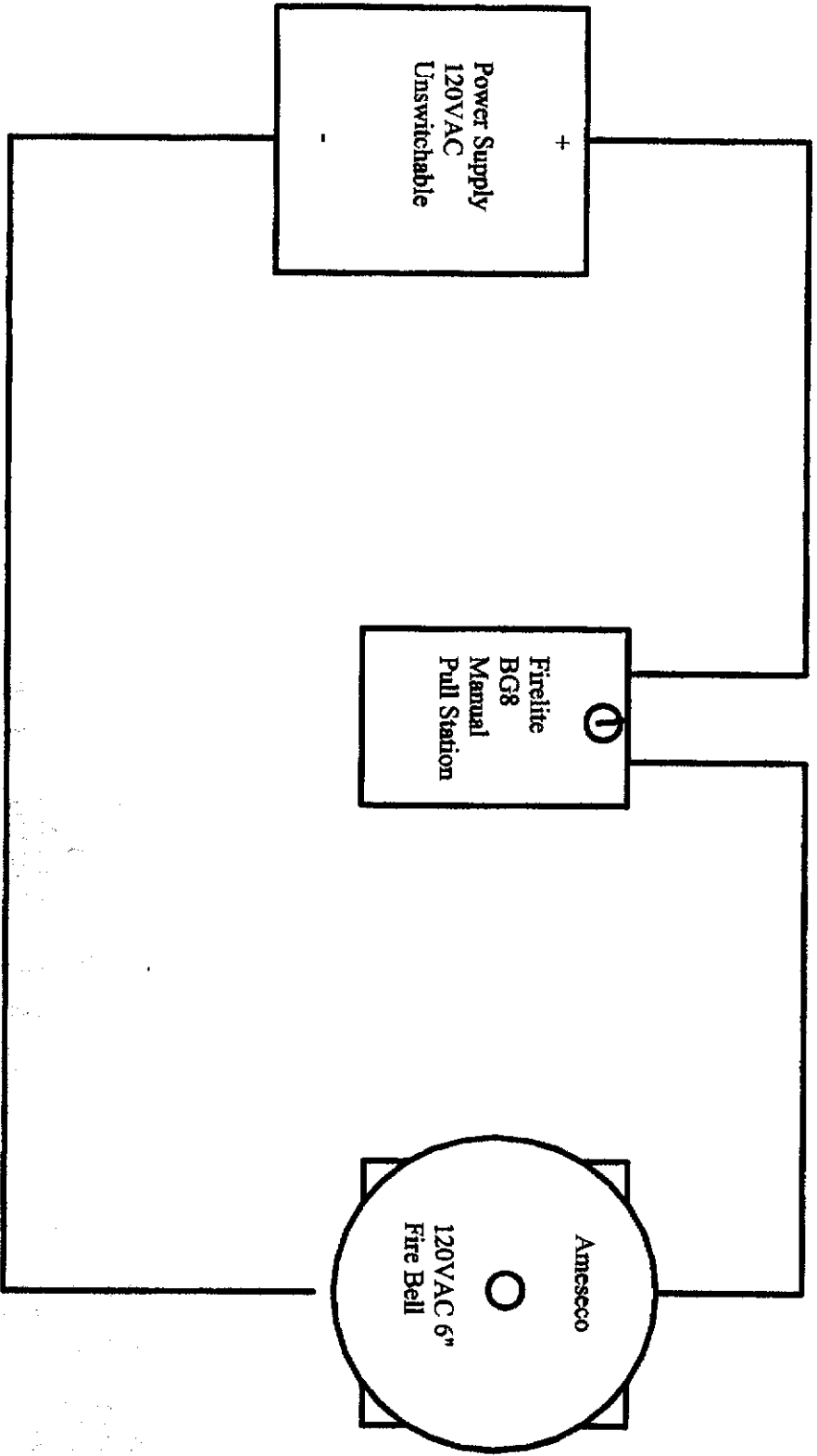

**Schematic for Alarm System
Special Care Homes**

ISSUED

JUN 23 1998

ALCOCK SAFETY EQUIPMENT
REPAIRS & SERVICES DIV.



Fire-Lite Alarms
INCORPORATED

BG-8 Series

Manual Fire Alarm Pull Stations

Catalog Section: Conventional Initiating Devices

February 28, 1996

GENERAL

The **BG-8** Manual Fire Alarm Pull Station provides a single-action, normally-open contact alarm initiating point for use with UL listed Fire Alarm Control Panels.

FEATURES

- Complies with Americans with Disabilities Act.
- Sturdy metal construction.
- Simple operation.
- Operation does not require replacement of parts.
- Drawing of flames on cover helps communicate purpose of this device to people who do not read English words.
- Designed to prevent false alarms when bumped, shaken, or jarred.
- Listed to UL 38.

APPLICATIONS

Designed for indoor use in atmospheres which are not potentially explosive. Use as a means of allowing anyone on the premises to turn in a non-coded alarm quickly, without chance of error. Typical uses include:

1. Schools.
2. Hospitals.
3. Retail stores.
4. Industrial plants.
5. Warehouses.

Compatible with any appropriate control panel to:

1. Initiate local alarm signals.
2. Trip a municipal fire alarm box.
3. Start fire pumps.
4. Any other function that can be initiated or controlled by the closing of a switch contact.

OPERATION

The stations feature non-break-glass operation.

They are operated by a pull on the pull cover. This causes a key latch to act against a retaining mechanism until adequate force is applied to open the station. As the station opens, a switch is released to initiate an alarm. The retainer in Model **BG-8** is a permanent, high-tensile, flat spring, which eliminates the need for a glass retainer. When so operated, the cover hangs down (and cannot be reset without use of a reset key) indicating that the station was used to initiate an alarm. **OPERATED STATIONS CAN BE SEEN UP TO 100 FEET AWAY.**

MEA

38-93-E



S711



California
State Fire
Marshal

7150-0075:148

ADA



BG-8
(Shown full size)

The attractive design of the stations highlights their engineered simplicity and unusual dependability; bumping, shaking, or jarring will not activate the switch or circuit. Instructions for operation of the station are clearly marked on the front of the pull cover.

This document is not intended to be used for installation purposes. We try to keep our product information up-to-date and accurate. We cannot cover all specific applications or anticipate all requirements. All specifications are subject to change without notice. For more information, contact Fire-Lite. Phone: (203) 484-7161 FAX: (203) 484-7118



Fire-Lite Alarms
INCORPORATED

12 Clintonville Road, Northford, Connecticut 06472

ISO-9001

Engineering and Manufacturing
Quality System Certified to
International Standard ISO-9001



Made in the U.S.A.



american security equipment company

Corporate Office & Warehouse
228 E. Star of India Lane
Carson, California 90746
Phone: (213) 538-4870
(800) 421-1086
Telex: 68-8241
FAX: (213) 538-8932

N. J. Office & Warehouse
P.O. Box 808
30 Chapin Road Bldg. F
Pine Brook, N.J. 07058
Phone: (201) 575-4433
FAX: (201) 575-5504

California State Fire Marshal Listing Number 7135-687:5

MSB Series



Patented

Motor Driven Bells 4 Wire Version with Varistor Suppression

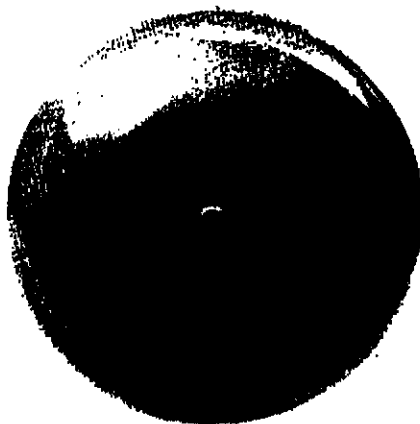

The MSB Bells 4 wire version complies with the new UL Standard 464 and are an excellent choice for fire signaling application.

The new MSB series bells are assembled with a VARISTOR SUPPRESSION ELEMENT that prevents RFI and EMF noise problems to the fire alarm control panel.

The MSB bells are available in 6", 8" and 10" gong and in 6, 12, 24 and 28V DC polarized.

The MSB Series -6B, -8B and -10B are UL Listed DC motor driven bells with a high quality micro-motor as its operating mechanism. The Micro-Motor operates with a low current consumption and does not require a high kick-out current when the bell initially rings.

The MSB bells can be used directly on a standard 4" electrical box or can be used either indoors or outdoors with weather proof back box, BBX-4.

The gong is all steel construction for longer life and louder sound output.

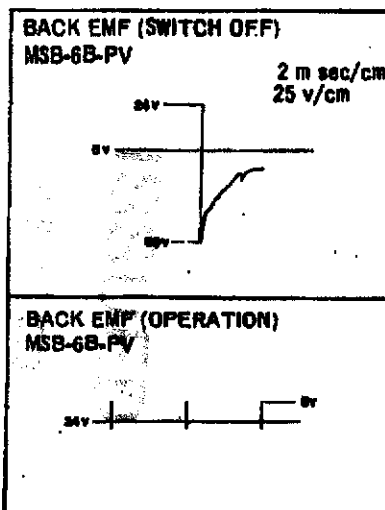
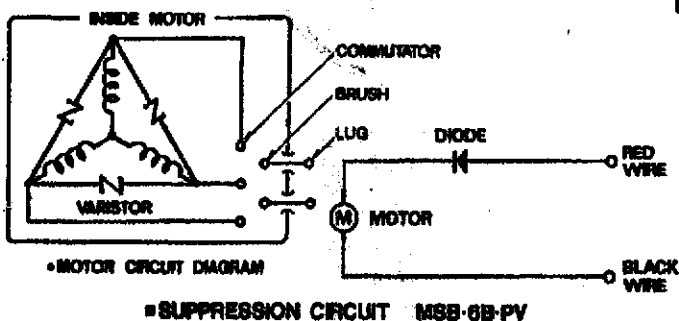

RFI (3 Meter Method) dB/at 3M dB: 1mV/m-0dB

Frequency (MHz)	Background Noise (dB)	EXB-6-PV
		Field Intensity (dB)
50	12	14
70	17	18
100	19	23
150	23	27
200	25	38

The field noise intensity denotes that of electric noise.



California Department of Forestry & Fire Protection
Office of the State Fire Marshal
PreFire Engineering
LISTING SERVICE

**Listing Expires
June 30, 1998**



LISTING No: 7135-0587:002 Page 1 of 1

CATEGORY: Audible Signal Device

LISTEE: American Security Equipment, 228 E. Star of India Ln, Carson CA 90746
Contact: Toby Tabata (213) 538-4670

DESIGN: Model EXB-6, EXB-8 and EXB-10 series. Refer to listee's data sheet for detailed product description and operational considerations.

INSTALLATION: In accordance with listee's printed installation instructions and applicable codes and ordinances.

MARKING: Listee's name, model number, electrical rating and UL label.

APPROVAL: Listed as audible devices for use with separately listed compatible control units.

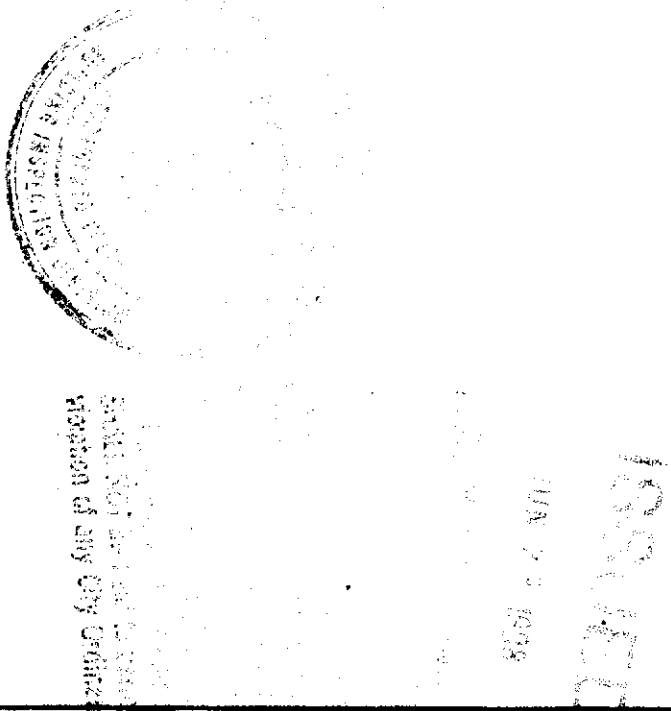

This listing is based upon technical data submitted by the applicant. CSFM staff has reviewed the test results and/or other data but does not make an independent verification of any claims. This listing is not an endorsement or recommendation of the item listed. This listing should not be used to verify correct operational requirements or installation criteria. Refer to listee's data sheet, installation instructions and/or other suitable information sources.

ISSUED: JULY 1, 1997
Effective issue date to expiration date

AUTHORIZED BY: 
Deputy **BEN G. HO**
Program Coordinator