

CITY OF SACRAMENTO
1231 I Street, Sacramento, CA 95814

Permit No: 0606060
Insp Area: 4
Thos Bros: 257G7

Site Address: 161 PINEDALE AV SAC
Parcel No: 226-0380-025

Sub-Type: RES
Housing (Y/N): N

CONTRACTOR
AGUIRRE ROOFING
3515 BINGHAMPTON DR
SACRAMENTO CA 95834

OWNER
MARTINEZ ELADIO
161 PINEDALE AVE
SACRAMENTO, CA 95838

ARCHITECT

Nature of Work: REROOF - T/O; RESHEET; INSTALL 28 SQ LIGHTWEIGHT TILE ON SFD & GAR

CONSTRUCTION LENDING AGENCY : I hereby affirm under penalty of perjury that there is a construction lending agency for the performance of the work for which this permit is issued (Sec. 3097, Civ. C).

Lender's Name _____ Lender's Address _____

LICENSED CONTRACTORS DECLARATION: I hereby affirm under penalty of perjury that I am licensed under provisions of Chapter 9 (commencing with section 7000) of Division 3 of the Business and Professions Code and my license is in full force and effect.

License Class C39 License Number 765880 Date 5-2-06 Contractor Signature [Signature]

OWNER-BUILDER DECLARATION: I hereby affirm under penalty of perjury that I am exempt from the contractors License Law for the following reason (Sec. 7031.5, Business and Professions Code; any city or county which requires a permit to construct, alter, improve, demolish, or repair any structure, prior to its issuance, also requires the applicant for such permit to file a signed statement that he or she is licensed pursuant to the provisions of the Contractors License Law (Chapter 9 (commencing with Section 7000) of Division 8 of the Business and Professions Code) or that he or she is exempt therefrom and the basis for the alleged exemption. Any violation of Section 7031.5 by any applicant for a permit subjects the applicant to a civil penalty of not more than five hundred dollars (\$500.00);

I, as a owner of the property, or my employees with wages as their sole compensation, will do the work, and the structure is not intended or offered for sale (Sec. 7044, Business and Professional Code: The Contractors License Law does not apply to an owner of property who builds or improves thereon, and who does such work himself or herself or through his/her own employees, provided that such improvements are not intended or offered for sale. If, however, the building or improvement is sold within one year of completion, the owner-builder will have the burden of proving that he/she did not build or improve for the purpose of sale.)

I, as owner of the property, am exclusively contracting with licensed contractors to construct the project (Sec. 7044, Business and Professions Code: The Contractors License Law does not apply to an owner of property who builds or improves thereon, and who contracts for such projects with a contractor(s) licensed pursuant to the Contractors License Law).

I am exempt under Sec. _____ B & PC for this reason: _____

Date _____ Owner Signature _____

IN ISSUING THIS BUILDING PERMIT, the applicant represents, and the city relies on the representation of the applicant, that the applicant verified all measurements and locations shown on the application or accompanying drawings and that the improvement to be constructed does not violate any law or private agreement relating to permissible or prohibited locations for such improvements. This building permit does not authorize any illegal location of any improvement or the violation of any private agreement relating to location of improvements.

PAID
CITY OF SACRAMENTO
MAY 02 2006
NEIGHBORHOOD SERVICES
AND DEVELOPMENT

I certify that I have read this application and state that all information is correct. I agree to comply with all city and county ordinances and state laws relating to building construction and hereby authorize representative(s) of this city to enter upon the abovementioned property for inspection purposes.

Date 5-2-06 Applicant/Agent Signature [Signature]

WORKER'S COMPENSATION DECLARATION: I hereby affirm under penalty of perjury one of the following declarations:

I have and will maintain a certificate of consent to self-insure for workers' compensation as provided for by Section 3700 of the Labor Code, for the performance of work for which the permit is issued.

WA I have and will maintain workers' compensation insurance, as required by Section 3700 of the Labor Code, for the performance of the work for which this permit is issued. My workers' compensation insurance carrier and policy number are:

Carrier STATE FUND Policy Number 1656828 Exp Date 10/01/2006

(This section need not be completed if the permit is for \$100 or less) I certify that in the performance of the work for which this permit is issued, I shall not employ any person in any manner so as to become subject to the workers' compensation laws of California and agree that if I should become subject to the workers' compensation provisions of Section 3700 of the Labor Code, I shall forthwith comply with those provisions.

Date 5-2-06 Applicant Signature [Signature]

WARNING: FAILURE TO SECURE WORKER'S COMPENSATION COVERAGE IS UNLAWFUL AND SHALL SUBJECT AN EMPLOYER TO CRIMINAL PENALTIES AND CIVIL FINES UP TO ONE HUNDRED THOUSAND DOLLARS (\$100,000) IN ADDITION TO THE COST OF COMPENSATION, DAMAGES AS PROVIDED FOR IN SECTION 3706 OF THE LABOR CODE, INTEREST AND ATTORNEY'S FEE.

THIS PERMIT SHALL EXPIRE BY LIMITATION IF WORK IS NOT COMMENCED WITHIN 180 DAYS.

0606060

GREGORIN DESIGN
9469 FORT WORTH WAY
SACRAMENTO, CA 95827

DATE: 04-27-06

RESIDENTIAL ROOF INSPECTION REPORT
161 PINEDALE AVENUE SACRAMENTO, CA

- field verify max. 5.8 psf
tile weight.

Prepared for:
Aguirre Roofing
3515 Binghampton Drive
Sacramento, CA 95834



This report was prepared in compliance with Sacramento City Code, Section 9.03.146 (D) 3) and is evidence that Frank L. Gregorin, P.E., with the assistance of Jose Aguirre (Roofer) has inspected the roof structure of the residence which is subject of this report. The sole purpose of this inspection and report is to determine the general conditions of the roof construction and evaluate it's structural adequacy for supporting the roof loads of the newly proposed roof assembly as prescribed herein.

The structure is a single family one story house built in the mid-1980's. The roof structure consists a 4:12 roof slope with 1x skip sheathing over of prefabricated gang-nailed roof trusses at 24" o.c. The chords and webs of the trusses consist of 2x4 framing. The existing roof framing shows no visible sign of distress or deterioration and are deemed to be in sound condition.

The loads to the existing roof structure expressed herein is exclusively meant for the application of Monier Villa - Duralite tile having an installed weight of 580 pounds per square (100 square feet) placed over 7/16" plywood or osb sheathing over existing roof framing as shown in the load table on page 2. Roofer may substitute other light-weight tile with the condition the prescribed allowable tile dead load of this report is not exceeded and an I.C.B.O. Evaluation Report showing the installed weight of the substituted tile is submitted to the Building Department for approval.

The Roofer shall bring to the attention of the Engineer of Record any wood found during the course of roofing work showing signs of deterioration (dry rot, termite infestation, etc.) or distress (splitting, warping, etc.). The Roofer will be liable for any repairs that were performed without the Engineer of Record's knowledge or consent.

It is the condition of this report that the Roofer, if requested, shall arrange for the Engineer of Record to perform additional inspection(s) of the existing roof framing and if necessary shall remove existing roof sheathing for purpose of inspection.

OFFICE / CITY COPY

JLG 5.2.06

Evaluation of roof loads for determining the adequacy of the existing roof trusses to support the newly proposed light-weight tile as prescribed in this report.

Based on the engineering practice of designing prefabricated roof trusses for a roof dead load of say no less than 10psf top chord loading.*

The weight of the new roof assembly will consist of:

(e) 2x4 top chord @ 24" o.c.	0.70 psf	
(e) 1x skip sheathing	1.13 psf	
(n) 7/16" sheathing	1.32 psf	
roofing paper	0.25 psf	
(n) light-weight tile	5.80 psf	(Installed weight, see load information in I.C.B.O. ER 2656 included with this report.)

$\Sigma =$ 9.20 psf

x 13/12 (5:12 roof slope adjustment)

9.97 psf

< 10 psf allowable
assumed for truss
top chord loading.

~~Say OK~~

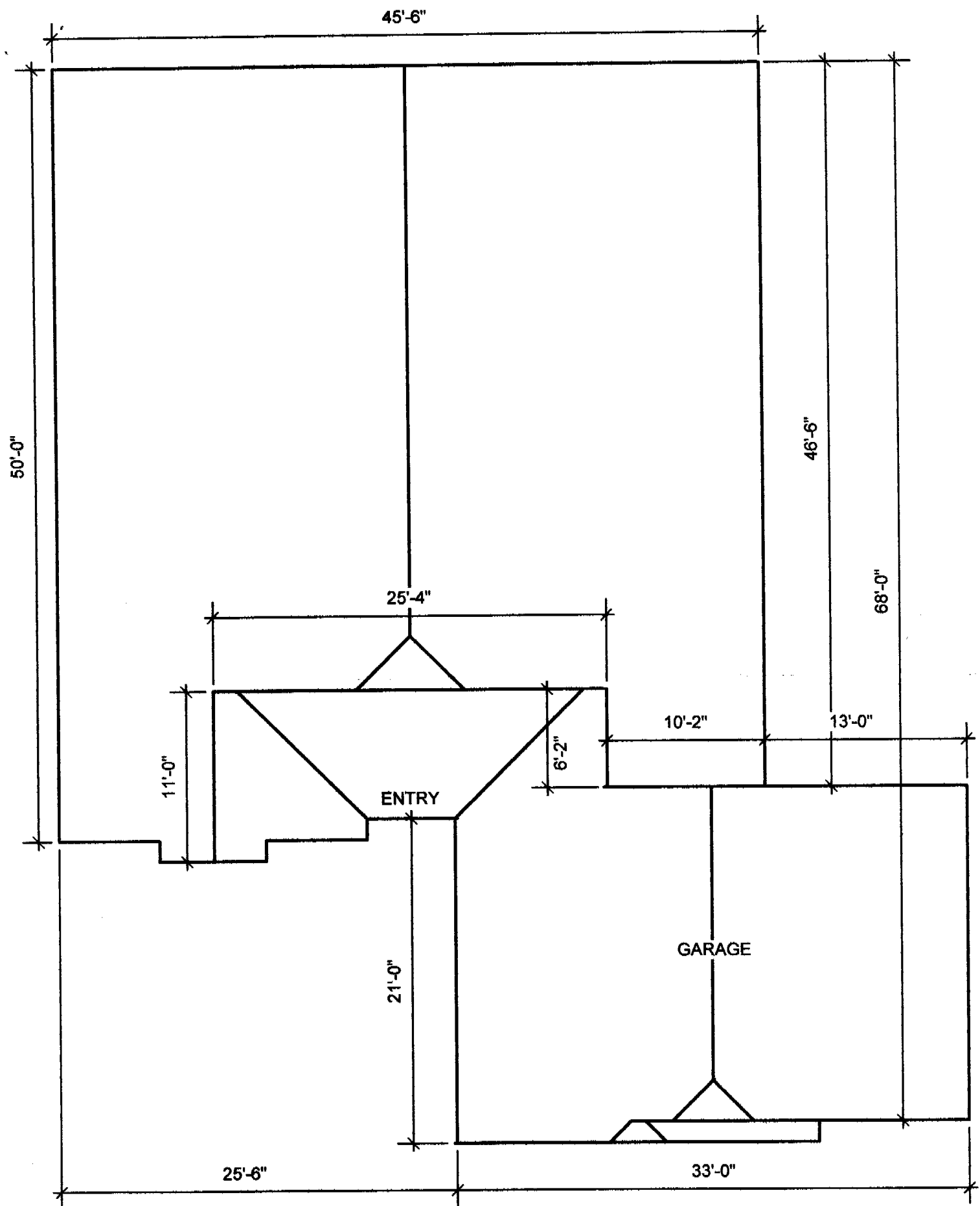

161 PINEDALE AVENUE
 SCHEMATIC ROOF PLAN
 (DIMENSIONS ARE APPROXIMATED)

EXTRUDED CONCRETE INTERLOCKING ROOF TILES

MONIER LIFETILE LLC
7575 IRVINE CENTER DRIVE
IRVINE, CALIFORNIA 92618-2930

1.0 SUBJECT

Extruded Concrete Interlocking Roof Tiles: Roma, Classic "100," Homestead, Mission "S," Shake, Slate, Split Shake, Split Slate, Country Shake, Country Slate, Country Split Shake, Country Split Slate, Cedarlite, Espana, Espana Tejas, Capri, Villa, Sentry Classic and Traditions.

2.0 DESCRIPTION**2.1 Materials:****2.1.1 Regular-weight Tiles:**

The extruded concrete roof tiles are interlocking elements having the dimensions and configurations shown in the accompanying table and figures. Accessory tile units are available for ridge, hip and gable areas. The regular-weight tiles are composed of portland cement and selected sand aggregates. The mix proportions are accurately maintained to ensure tile production in accordance with the specifications. Anchor lugs, located on the underside of all tiles except Cedarlite, overlap wood battens, purfins or spaced sheathing for anchorage in the plane of the roof. Holes are provided in each tile for fastening where required by the installation. Interlocking ribs are provided on the longitudinal edges of the tiles to restrict lateral movement and provide a water stop. In addition, transverse bars are provided on the underside to serve as weather checks. Mineral coloring oxides are either applied to the exposed surface in a cementitious material or mixed integrally with the tile mix to produce a through-colored product. The tiles are cured to reach required strength before shipment. See Table 1 for product designations, dimensions and installed weights. See Figure 1 for tile profiles.

2.1.2 Lightweight Tiles: Duralite tiles are manufactured in the same manner and size, and with the same profiles, as regular-weight tiles, but the tiles are comprised of portland cement, lightweight aggregate and proprietary ingredients. See Table 1 for product dimensions and installed weights.

2.1.3 Cedarlite: Cedarlite tiles are manufactured in the same manner as regular-weight tiles, except they are comprised of portland cement, lightweight aggregates and proprietary ingredients, and have a wood shake appearance and flat backside.

2.2 Installation—New Construction:

2.2.1 General: Installation shall be in accordance with Tables 15-D-1 and 15-D-2 of the code, except as noted in this report. Care must be taken to ensure both horizontal and vertical alignment on the roof. Foreign particles must be cleaned from all interlocking areas, to ensure correct fit and prevent water damming. Cracked or broken tiles must not be installed or allowed to remain on the roof.

2.2.2 Sheathing: Sheathing must be structurally adequate to support the loads involved. At a minimum, spaced sheathing boards must be nominal 1-by-6 lumber spanning a maximum of 24 inches (610 mm). Solid and spaced sheathing must be fastened in accordance with the code.

2.2.3 Underlayment: Tiles installed on roofs with slopes less than 2½:12 (21% slope) are considered decorative only, and must be applied over an approved roof covering, subject to local building official approval.

On roofs with slopes of 2½:12 (21% slope) to less than 3:12 (25% slope), an approved built-up roof applied in accordance with Table 15-D-1 of the code or an approved single-ply roof membrane assembly must be installed prior to installation of the tiles.

On solidly sheathed roofs with slopes of 3:12 (25% slope) to less than 4:12 (33% slope), underlayment may be as described in this section for roof slopes of 2½:12 (21% slope) to less than 3:12 (25% slope), or may be a single layer of Type 90, granular-surfaced, asphalt roll roofing, or two layers of Type 30 felt installed shingle fashion, or other approved single-ply systems installed in accordance with the code or an ICBO ES evaluation report.

Over solid sheathing, on roofs with slopes of 4:12 (33% slope) or greater, underlayment must be one layer of minimum Type 30 felt either complying with ASTM D 226 or recognized in an ICBO ES evaluation report, and must completely cover the decking.

When the tiles are installed over spaced sheathing, the underlayment must comply with the ICBO ES Acceptance Criteria for Concrete Tile Underlayment on Spaced Sheathing (AC08). The underlayment must be draped over the rafters, with a 4-inch (152 mm) headlap and a 6-inch (152 mm) side-lap.

Underlayment must be lapped over hips and ridges, and lapped or laced through the valleys. Hip and ridge nailers must also be covered.

See Section 2.2.9 for application of underlayment in areas subject to roof ice buildup.

2.2.4 Battens:

2.2.4.1 Cedarlite Tiles: Battens installed for Cedarlite tiles must be nominal 1-by-3 wood. The battens must be fastened as described in Section 2.2.4.3, and spaced at 10 inches (254 mm) on center. The top edge of the Cedarlite tile must be aligned with the top of the batten.

2.2.4.2 All Other Tiles: Battens are required on solidly sheathed roofs with slopes below 3:12 (25% slope) in order to minimize membrane penetration, and above 7:12 (58.3% slope) to provide positive tile anchorage. Battens must be fastened either with corrosion-resistant 8d common or box nails or approved equal, spaced at 24 inches (610 mm) on center; or with 1½-inch-long (38 mm), 7/16-inch-crown (11.1 mm), No. 16 gage, corrosion-resistant staples spaced a maximum of 12 inches (305 mm) on center.

ES REPORTS™ are not to be construed as representing aesthetics or any other attributes not specifically addressed, nor are they to be construed as an endorsement of the subject of the report or a recommendation for its use. There is no warranty by ICBO Evaluation Service, Inc., express or implied, as to any finding or other matter in this report, or as to any product covered by the report.



prior to installation of battens in accordance with Section 2.2.4.

2.3.3 Eave Preparation: Existing roof material shall be cut back to allow installation of a raised fascia board or eave closure material, flush with the end of the roof sheathing in accordance with Section 2.2.5.

2.3.4 Flashing: New pipe flashing and minimum 24-inch-wide (610 mm) metal valley flashing shall be installed over existing flashing. Existing chimney and wall-counter flashing shall be used only if they are in good condition and sufficient height exists to insert new tile flashing. Flexible flashing shall be used with profiled tiles.

2.3.5 Wood Shakes and Shingles: Existing wood shakes and shingles shall be removed and tiles installed as for new construction.

2.4 Roof Classification:

When installed in accordance with Section 2.2 of this report, the roof tiles are noncombustible roof coverings in accordance with Section 1504.1 of the UBC. When installed over minimum $1\frac{5}{32}$ -inch-thick (11.9 mm) plywood, in accordance with Section 2.2 and in the reroofing applications described in Sections 2.3.1 through 2.3.4 of this report, the tiles are Class A roof coverings, in accordance with Section 1504.2 of the code.

2.5 Identification:

The underside of each field tile is imprinted with the Monier Lifetile LLC logo or the name Monier, Lifetile or Boral Lifetile. Pallets bear a tag with the Monier Lifetile LLC name and address, the evaluation report number (ICBO ES ER-2656) and the installed weight of the product. Cedarlite tiles also have an "M" imprinted on the top side of the tile.

3.0 EVIDENCE SUBMITTED

Reports of tests conducted in accordance with the ICBO ES Acceptance Criteria for Special Roofing Systems (AC07), dated April 1999, and installation and quality control details.

4.0 FINDINGS

That the extruded concrete interlocking roof tiles described in this report comply with the 1997 *Uniform Building Code*TM, subject to the following conditions:

- 4.1 They are manufactured, identified and installed in accordance with this report and the manufacturer's instructions.
- 4.2 They are manufactured at plants located in Phoenix, Arizona; French Camp, California; Gilroy, California; Lathrop, California; Rialto, California; San Bernardino, California; Kapolei, Hawaii; Henderson, Nevada; Katy, Texas; and Tacoma, Washington.

This report is subject to re-examination in one year.

TABLE 1—TILE DIMENSIONS AND WEIGHTS

TILE DESIGNATION	INSTALLED WEIGHT ¹ (psf)	LENGTH (inches)	WIDTH (inches)	HEIGHT (inches)
Espana	9.0	17	12 ³ / ₈	3
- Regular weight	5.5	17	12 ³ / ₈	3
- Duralite				
Espana, Tejas	9.0	16 ¹ / ₂	13 ¹ / ₈	2 ³ / ₄
Mission "S"				
- Monier 2000	9.5	16 ¹ / ₂	13	2 ¹ / ₂
Capri				
- Regular weight	9.5	17	12 ³ / ₈	2 ¹ / ₈
- Duralite	5.5	17	12 ³ / ₈	2 ¹ / ₈
Sentry Classic	9.5	16 ¹ / ₂	13	2 ¹ / ₄
Villa				
- Monier 2000	9.3	16 ¹ / ₂	13	2 ¹ / ₈
- Duralite	5.8	16 ¹ / ₂	13	2 ¹ / ₈
Roma	9.3	16 ¹ / ₂	13	2
Classic "100"	9.5	16 ¹ / ₂	13	1 ³ / ₄
Shake, Country Slate, Country Shake, Colonial Slate, and Split Shake				
- Regular weight	10.3	17	12 ³ / ₈	1 ¹ / ₄
Shake, Sentry Slate, Country Shake, Country Slate, Country Split Shingle and Country Split Slate (Split Slate—Texas plant only)				
- Regular weight	10.3	16 ¹ / ₂	13	1 ¹ / ₄
Homestead	9.5	16 ¹ / ₂	13	1 ¹ / ₄
Split Shake and Slate Flat				
- Tradition	10.3	16 ¹ / ₂	13	1 ¹¹ / ₁₆
- Premium Duralite	7.4	16 ¹ / ₂	13	1 ¹¹ / ₁₆
Cedarlite	5.6	13 ¹ / ₂	13	3/4
Monier 2000 Split Shake and Monier 2000 Slate	9.5	16 ¹ / ₂	13	1
Duralite Split Shake, Duralite 2000 Shake and Duralite Slate	5.7	16 ¹ / ₂	13	1

For SI: 1 inch = 25.4 mm, 1 psf = 0.0479 kPa.

¹Installed weight was determined with a 3-inch headlap.

It should be noted that the installation of rake trim tiles, whether flat or profile, is similar. The options for rake trim tiles lie in the various treatments of end condition detailing.

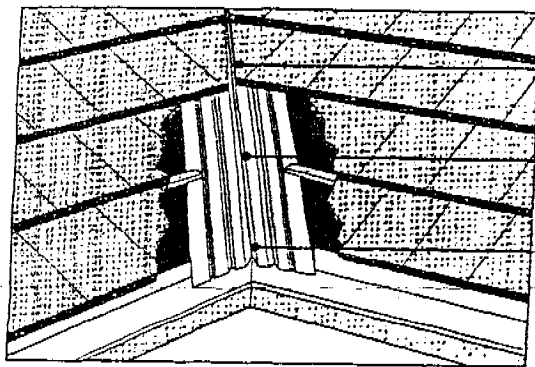
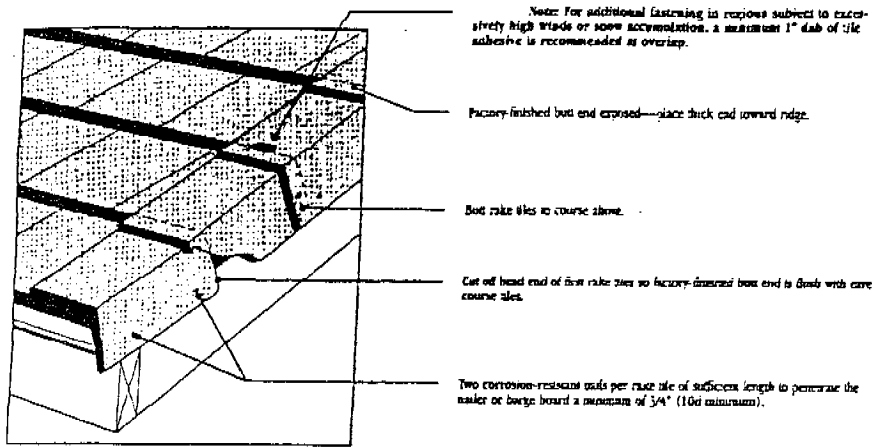

CLOSED VALLEY

Standard closed valley treatment
Cut tiles not attached to batten or batten extender must be attached by wire and/or adhesive or cut tile clips.

- No. 28 gauge (minimum) galvanized ribbed valley flashing
- No. 26 gauge G-90 galvanized ribbed valley flashing

Minimum 1" standing seam splash diverter

Remove portion of tile heading where tile rests on metal flashing to prevent water damming.

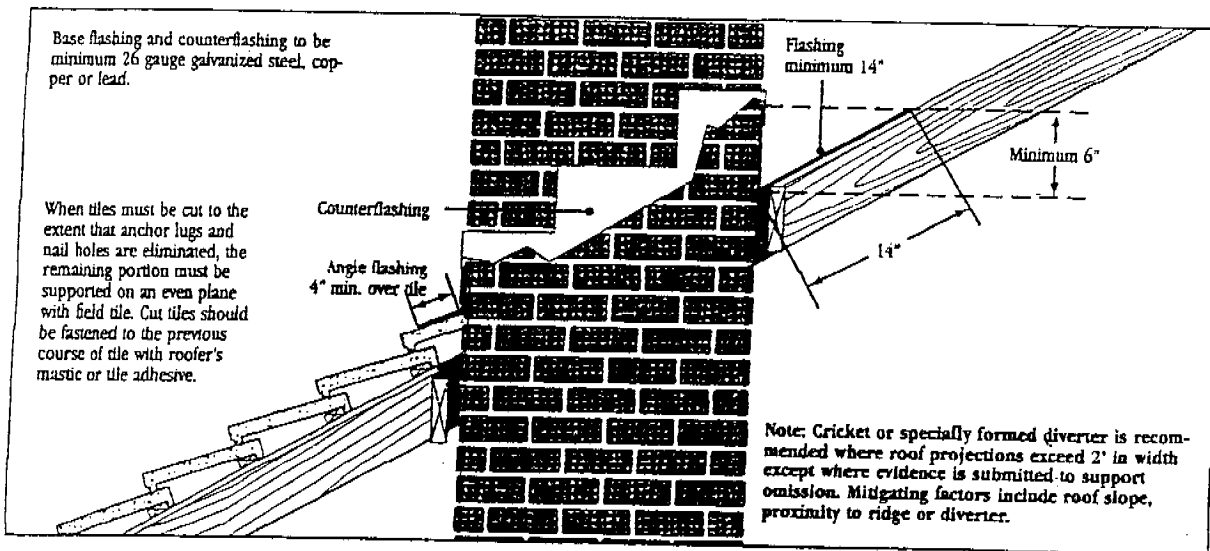
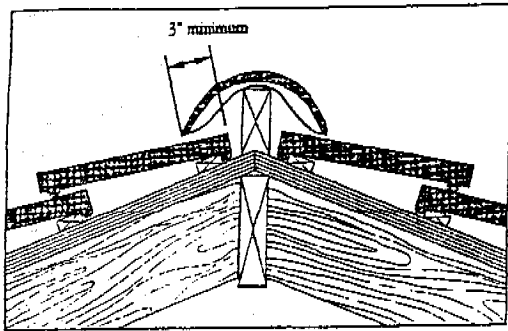

FIGURE 2—TYPICAL INSTALLATION DETAILS—(Continued)



Typical Ridge Condition

Trim is to be fastened with one corrosion-resistant nail of sufficient length to penetrate nailer board a minimum of 3/4" - 10d minimum.

Trim tile covers field tile minimum 3".

Underlayment carried over or carried under ridge nailer.

Optional second layer of felt over nailer board as weatherblock.

Place last batten 1/8" from center of ridge nailer.

In severe climate areas, the ridge must be sealed with metal, mortar, mastic or pressure sensitive adhesive where tile meets ridge board.
Roofers' mastic or tile adhesive must be applied at headlap to cover nail hole.

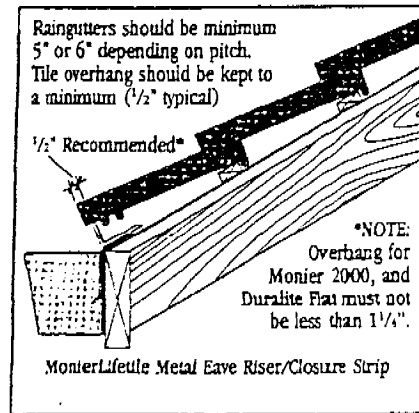

SOIL PIPE AND VENT FLASHING



STEP 1

Underlayment

Riser flashing must extend 6" from cone or be completely sealed to the underlayment.

Decking

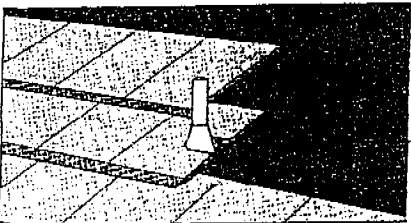

STEP 2

Roof tile to accept flashing

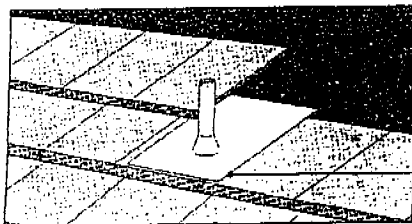

STEP 3 - Standard Galvanized or Lead Flashing

Flashing must extend a minimum 6" from the cone for flat tile and 9" on profile tile.

On short cone flashings, pipe collar or sealant is required. Slanted flashings must be tucked into pipe or capped.

Side Groups are optional in all regions

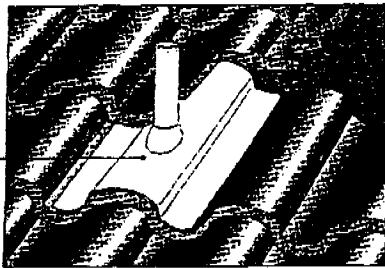

For profile tiles, use lead or other flexible-type flashing, minimum 18" shunt around roof protection—attach to tile with approved roofer's mastic.

FIGURE 2—TYPICAL INSTALLATION DETAILS—(Continued)

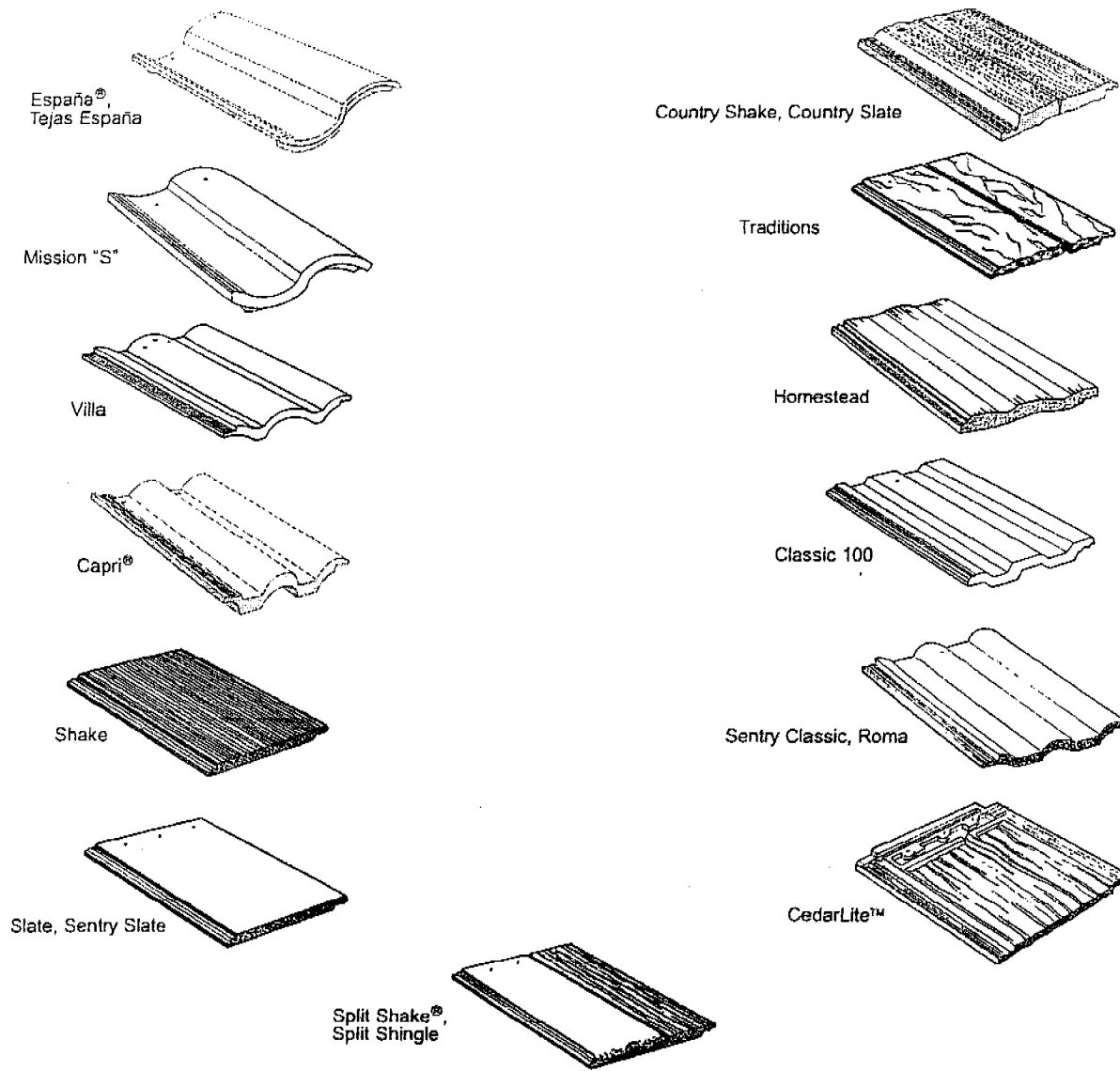
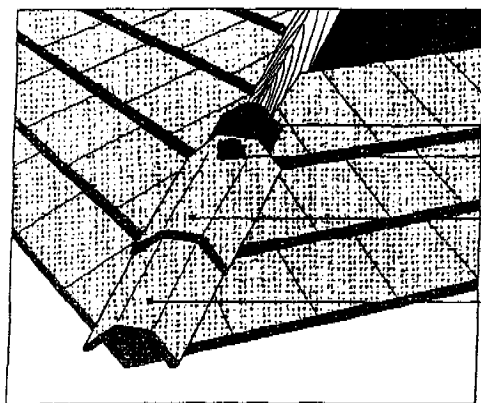

FIGURE 1—TILE PROFILES

HIP TRIM DETAILS

It should be noted that the installation of hip trim tiles, whether flat or profile, is similar. The options for hip trim tiles lie in the various treatments of end condition detailing.



Field tiles should be cut to within an average of 1/8" of nailer board.
 Nail each trim with a corrosion-resistant nail of sufficient length to penetrate nailer board a minimum 3/4".
 Cut tiles without nail holes may be drilled, notched and nailed or affixed with tile adhesive, wire and/or cut tile clips.
 Roofer's mastic or tile adhesive must be applied at headlap to cover nail hole.
 Provide a minimum 2" headlap.
 Hold back hip trimer 6" from eave edge.
 Suggested nailer sizes for Mission are 2" x 6". All others require 2" x 4".
 When counterbuttens are used, the nailer board must be increased accordingly. Steep pitches may require reduction in nailer board size.
 Note: Mission must be sealed in all regions.
 2" x 8" nailers may be necessary when using high barrel trim.

FIGURE 2—TYPICAL INSTALLATION DETAILS

On roofs with slopes of 2 1/2:12 (21% slope) to less than 3:12 (25% slope), nominal 3/8-inch (9.5 mm), decay-resistant wood lath strips are attached vertically to framing over the underlayment, from eave to ridge, at 24 inches (610 mm) on center. Battens must be structurally adequate to support expected loads, but not smaller than nominal 1-by-2 boards, and must be fastened through the vertical lath with minimum 8d corrosion-resistant box nails or approved equal.

When used on roofs with slopes of 3:12 to 21:12 (25% slope to 175% slope), battens must be fastened to the roof deck at a maximum of 24 inches (610 mm) on center. Battens must have provisions for drainage either by providing a 1/2-inch (12.7 mm) separation at the batten ends every 4 feet (1219 mm), or by shimming with decay-resistant wood or strips of material such as asphalt cap sheet or shingles spaced no more than 12 inches (305 mm) on center. Battens must be spaced to maintain a minimum 3-inch (76 mm) headlap when tiles are installed.

See Section 2.2.9 for installation of battens in severe climate areas.

2.2.5 Eaves: An eave closure strip or other approved special accessory must be installed to ensure that the eave course of tiles lies in the same plane as the remainder of the field. In areas determined by local building officials to be subject to blowing dust or snow, eave closure strips are required with Espana and Mission "S" tiles. Where solid fascia material is attached to rafter ends and extends above the plane of the deck to act as a first-course riser, an anti-ponding device must be used to support the underlayment.

2.2.6 Fastening:

2.2.6.1 Field Tile: Tiles shall be fastened in accordance with Tables 15-D-1 and 15-D-2 of the code. Tile nails shall be minimum No. 11 gage corrosion-resistant steel nails having a minimum 5/16-inch (7.9 mm) head diameter, and sufficient length to penetrate 3/4 inch (19 mm) into framing or battens or through the thickness of the sheathing, whichever is less. When battens are not used, every tile shall be nailed.

Cedarlite tiles must be fastened to the sheathing with two nails per tile in accordance with Table 15-D-1 of the code. As an alternative, on minimum 7/16-inch-thick (11.1 mm) oriented strand board or minimum 15/32-inch-thick (11.9 mm) plywood, a single buglehead wood screw, in the center fastener hole, may be used. The screw must be of sufficient length to penetrate through the deck approximately 1/4 inch (6.4 mm) minimum. The screw head is driven to a point that allows the face end of the tile to lift 1/4 to 1/2 inch (6.4 to 12.7 mm) above the tile below. The buglehead screw must have a head diameter of 0.328 inch (8.3 mm) and a shank diameter, between threads, of 0.132 inch (3.35 mm).

2.2.6.2 Trim Tile: Nailers boards of sufficient height to adequately support hip or ridge tiles either must be fastened into framing with two 10d nails at 24 inches (610 mm) on center or two 20d nails at 48 inches (1219 mm) on center, or are secured using galvanized steel strapping or special galvanized steel attachment devices at 48 inches (1219 mm) on center. Each hip and ridge tile is attached to the nailer board with one No. 11 gage, corrosion-resistant nail of sufficient length to penetrate 3/4 inch (19.1 mm) into or through the thickness of the supporting member. Nose ends must be set in a bead of roofer's mastic or an adhesive complying with ASTM C 920-87 that also covers the nail head. All rake tiles must be fastened with two nails. The junction of the field tile and the hip and/or ridge must be weatherproofed with a dry ridge/hip system, a bed of mortar or other approved bedding material in accordance with the manufacturer's instructions.

2.2.7 Flashing: Valley flashing must be in accordance with Section 1508 of the code. All other flashing must comply with Section 1509 of the code. Openings through the tile for penetrations such as vents must be flashed in accordance with the

code and supported by additional blocking or roof framing as required. Flashing around pipes, vents and flues shall consist of a sub-flashing at the deck and a top flashing fitted in with the tile application. Flashing for profile tile must be made of lead or other approved flexible material and must be formed to the contours of the tile.

A weatherblock is required at headwalls, hips and ridges when installing Espana or Mission "S" tiles. Weatherblock is optional for all other profiles. Weatherblock materials include mortar, foil-backed pressure-sensitive adhesive, flexible metal formed to fit the tile, preformed plastic, neoprene or metal formed to fit the tile, and coated rigid foam.

2.2.8 Broken Tile Replacement: The broken tile is first removed. If battens were used originally, existing nails, if any, are cut and new tile inserted. If no battens were used, the old fastener is removed and the hole in the underlayment repaired with roofing cement. A 6-inch-by-6-inch-by-1/2-inch (152 mm by 152 mm by 12.7 mm) plywood piece is nailed to the deck to act as a batten. The new tile is then inserted.

2.2.9 Severe Climate Considerations: In areas designated by local building departments as subject to rooftop accumulation of snow or rain driven by high winds, openings at hips, ridges and walls must be closed with metal or mortar, or approved sealant material. In areas subject to severe ice build-up at the eaves, tiles must not be installed on roof slopes below 4:12 (33% slope). Roof ventilation described in Section 1505.3 of the code must be provided.

Horizontal battens must be installed on top of nominal 1-by-4 vertical battens, to allow air flow between the roof deck and the installed tile. Vertical battens must be installed at 12 or 16 inches (305 or 406 mm) on center, or at up to 24 inches (610 mm) on center if fastened into rafters. Horizontal battens must be minimum 1-by-4 wood, fastened through the vertical battens. All tiles are nailed through horizontal battens. In areas where basic wind speeds exceeding 80 mph (129 km/h) exist, directions in Table 15-D-2 of the code must be followed. Underlayment application must comply with Tables 15-D-1 and 15-D-2 of the UBC.

2.3 Installation—Reroofing Applications:

2.3.1 General: Reroofing shall comply with Chapter 15 and Appendix Chapter 15 of the UBC. Care must be taken to ensure both horizontal and vertical alignment of tiles and battens on the roof. Foreign matter shall be cleaned from all interlocking areas. Cracked or broken tiles shall not remain on the roof. Damaged or rusted flashings should be replaced. Existing framing must be adequate for the additional load. The existing roof must be inspected in accordance with Appendix Chapter 15, Section 1515, of the code. When installed over existing spaced sheathing boards, with or without battens, either plywood, or an underlayment complying with the code or an underlayment specifically recognized for this type of use in an ICBO ES evaluation report may be used. When installed over solid sheathing, one layer of Type 30 felt or approved equivalent underlayment shall be installed on the roof prior to application of the tile. In lieu of this underlayment, the building official may determine that the existing roof covering provides the equivalent underlayment protection.

The minimum allowable roof slope is 3:12 (25% slope). Details not covered under this section are identical to those described in Section 2.2. Fasteners shall be of sufficient length to penetrate through the roof sheathing or a minimum of 3/4 inch (19.1 mm) into the structural framing, whichever is less. Battens shall be installed in accordance with Section 2.2.4.

2.3.2 Deck Preparation:

2.3.2.1 Asphalt Shingles: Wood batten strips shall be provided for roofs with slopes over 7:12 (58.3% slope).

2.3.2.2 Rock or Gravel Roofs: The existing roof deck shall be swept clean of all loose rock and gravel. One layer of minimum Type 40 coated base sheet shall be applied to the deck